



2023-2024

INTERNATIONAL EDITION



Technical Solutions in the industry





In 1994, Bemis Electric was established in Bursa where is an important industry city of Turkey. Bemis that was established with the purpose of producing industrial electric materials, started producing with 3 types of flat type plug socket three-phase, and became the leader of its sector in a short time.

Bemis is producing 3.000 types of industrial Electric materials with 100 % domestic production in 11.000 m2 indoor space in its modern production plant in Bursa Organized Industrial Zone.

Bemis, holding ISO 9001-2008 QUALITY MANAGEMENT SYSTEM, CE, CB, TSE, GOST-R, UkrSEPRO and TÜV Quality Documents, maintains its leadership in the sector with its well-educated and experienced team.

As an addition to the local market, BEMIS export products to more than 48 countries. Mostly exported products are CEE norm plugs and sockets, plastic and metallic cable reels, rubber plugs and more brand new products and they are presented proudly to the use of international consumers. Our new motto is "DISCOVER BEMIS WORLD "

Bemis has reached to the level of a well-known and significant manufacturer in the sector – with the motto and vision of "becoming a leader brand in the world – known with its' quality and esteemed name." BEMIS controls all the international sales and operations from the central manufacturing facilities in either direct or export-aimed sales to worldwide buyers. And also Bemis looking for a new partners for expand the sale network in the World. Join us for grow your Business.

For International Sales

Telephone

+90 224 363 30 65

Mobile

+90 549 797 10 51

Web

www.bemis.com.tr

e-mail

sales@bemis.com.tr

Factory Adress

Bursa Organize San. Böl. Green Cpcs. No:31 Nilüfer / Bursa - Turkey

Europe Branch



Factory



For quality, labs and tests are important

We certify almost all of our products by testing in our laboratory within our organization, we control quality and improve it by tracking deviations in tolerances.

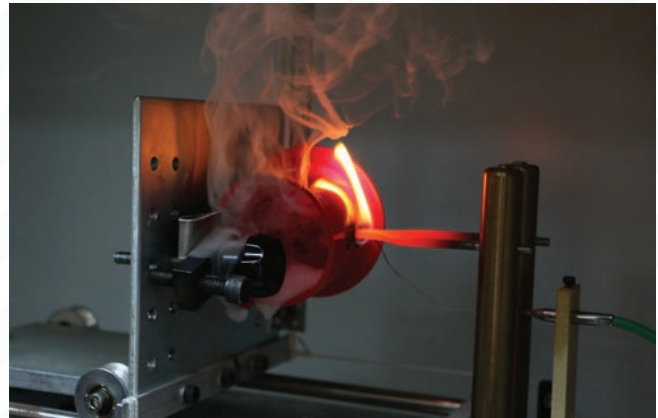
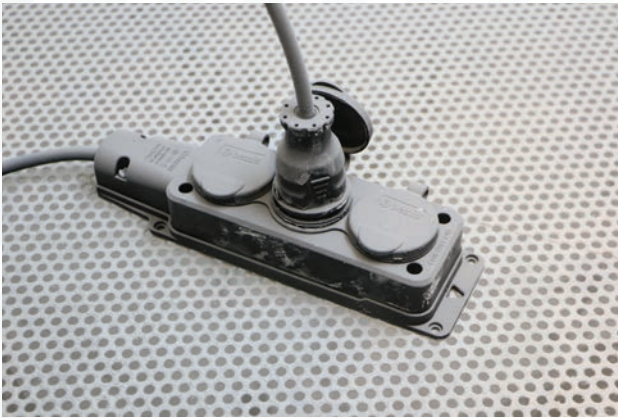

R&D & Mould

Bemis Electric has opportunity to make mould and equipment that are required for product design and producing with its moulding shop and R&D unit. Besides, by following new market trends, it replies customer demand as soon as possible. Bemis left 3 % of its turnover for R&D.

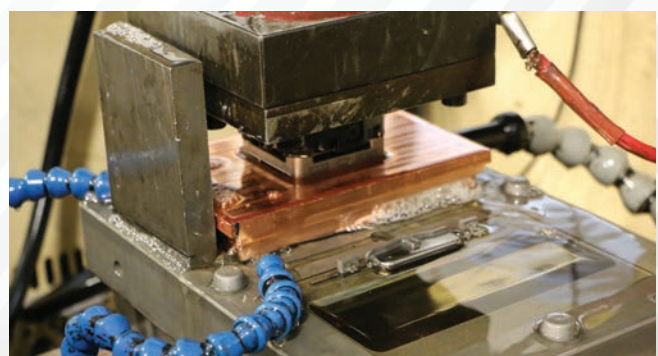

Certificates



Exhibition and Trade Shows





NO DRILL



NO SCREWDRIVER



NO SCREWS

The first and only in the world. 16A. screwless panel socket



German and French type

Very Practical, Screwless ASSEMBLY



In today's conditions, the shortage of technical staff, high man hour costs we manufacturers to make more practical, more robust designs. not compelled. In this context, we have done As a result of R&D studies, very serious we made progress. Although it is a small product 4 point assembly and after assembly After this product, which has difficulty in connecting the cable, we've solved both assembly challenges. Our new product screwless mounting and screwless It is very practical and convenient by providing cable connection. becomes more robust. Attention all users is presented.

5 YEARS WARRANTY



Rubber - Plastic Plug & Socket

Monophase - Caravan - Arc

5 YEARS WARRANTY



CEE Norm Plug and Socket Series

16A - 32A - 63A - 125A

5 YEARS WARRANTY



CEE Norm Plug and Socket Series

24 Volt series

5 YEARS WARRANTY



TriBox

16A - 32A

5 YEARS WARRANTY



PolyBox

16A - 32A

2 YEARS WARRANTY



PowerBox

2 YEARS WARRANTY



Interlock

16A - 32A - 63A

2 YEARS WARRANTY



Lighting

Transformer and Hand Lamp

5 YEARS WARRANTY



Combinations

V5 - V7 - V10 - V12 - V17 - V26

5 YEARS WARRANTY



Enclosure Box

Aluminum - Plastic

5 YEARS WARRANTY



Button Box

Aluminum - Plastic

5 YEARS WARRANTY



Cable Reel

Metal - Plastic

2 YEARS WARRANTY



Spare Part

IP54

RUBBER GROUP SOCKET PRODUCT FEATURES

5 YEARS WARRANTY

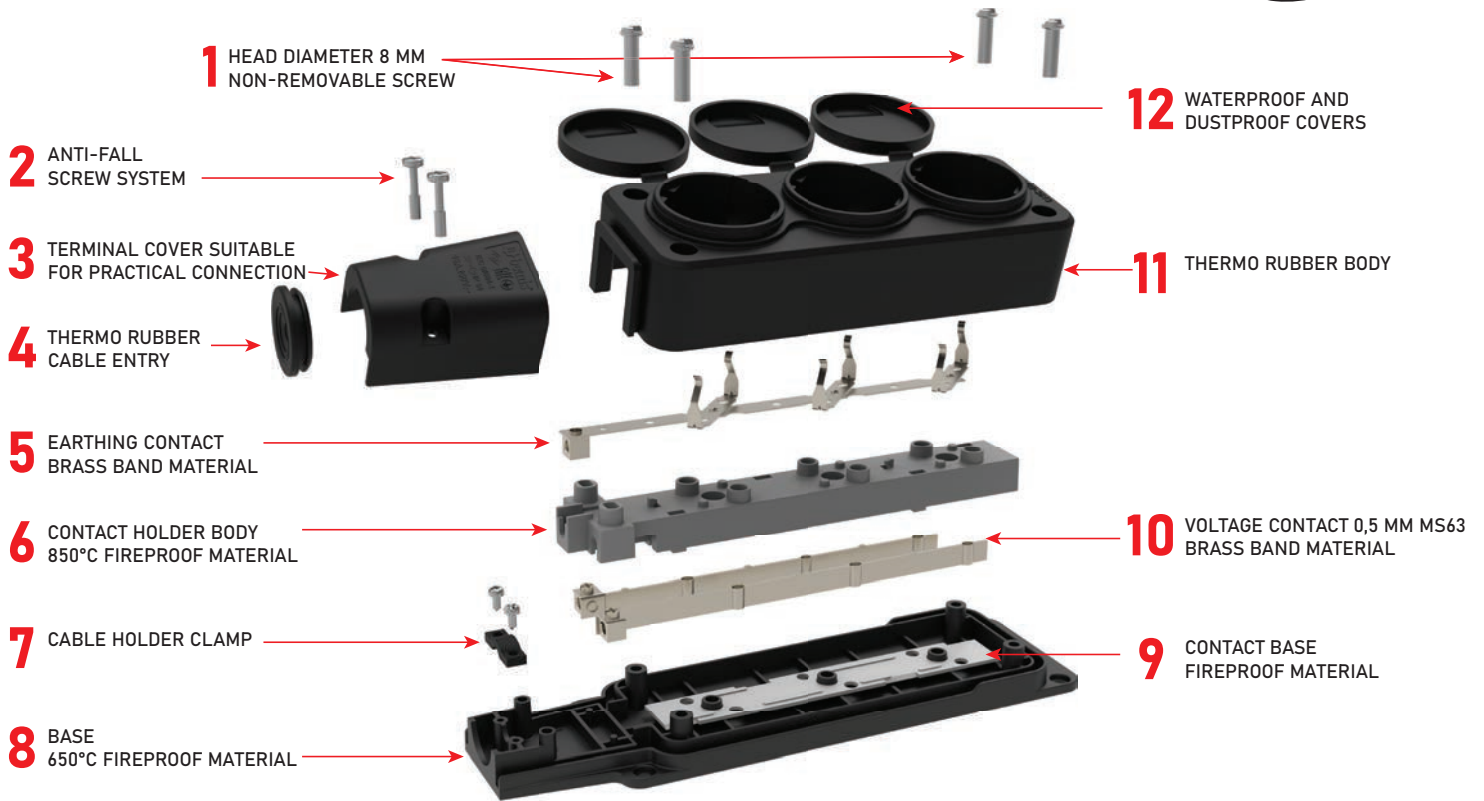

All the necessary tests have been performed in Bemis laboratory



IP68 Monophase Series 1x16A. (2P+E) 200/250V.

Brand New
Brand New
Brand New
Brand New
Brand New
Brand New

Product Code	Description	IP	Box	Pack
BS1-1402-7011	Straight Plug	IP68	10	120
BS1-1402-7311	Connector Socket	IP68	10	120
BS1-1402-7114	Panel Mounted Plug	IP68	8	144
BS1-1402-7510	Surface Mounted Socket with Screw Connection	IP68	6	72
BS1-1402-7511	Surface Mounted Socket with Quick Connect	IP68	6	72
BS1-1402-7210	Surface Mounted Plug	IP68	6	72
BS1-1402-7535	90° Angled Surface Socket	IP68	3	54
BS1-1402-7236	90° Angled Surface Plug	IP68	3	54
BS1-1402-7410	Screw Connected Panel Mounted Socket	IP68	8	144
BS1-1402-7416	Quick Connect Panel Mounted Socket	IP68	8	144
BS1-1402-7417	Quick Connect Panel Mounted Socket (with child protection)	IP68	8	144
BS1-1402-7440	Screwless Panel Socket with Screw Connection	IP68	12	216
BS1-1402-7446	Quick Connect Screwless Panel Socket	IP68	12	216
BS1-1402-7476	Quick Connect Screwless Panel Socket (with child protection)	IP68	12	216

Straight Plug



BS1-1402-7011

Panel Mounted Plug



BS1-1402-7114

90° Angled Surface Plug



BS1-1402-7236

Surface Mounted Plug



BS1-1402-7210

Connector Socket



BS1-1402-7311

90° Angled Surface Socket



BS1-1402-7535

Surface Mounted Socket with Screw Connection



BS1-1402-7510

Surface Mounted Socket with Quick Connect



BS1-1402-7511

Screw Connected Panel Mounted Socket



BS1-1402-7410

Quick Connect Panel Mounted Socket



BS1-1402-7416

Screwless Panel Socket with Screw Connection



BS1-1402-7440

Quick Connect Screwless Panel Socket



BS1-1402-7446

Monophase Rubber Series 1x16A. (2P+E) 200/250V.

Product Code	Description	IP	Box	Pack
BK1-1402-2011	Straight Plug	IP44	30	540
BK1-1402-2311	Connector Socket	IP44	25	300
BK1-1402-3511	Surface Mounted Socket	IP54	12	216
BK1-1402-3612	2way Socket	IP54	8	144
BK1-1402-3613	3way Socket	IP54	7	126
BK1-1402-3614	4way Socket	IP54	8	96
BK1-1402-2022	Angled Plug	IP44	20	360
BK1-1402-2021	Handle Angled Plug	IP44	20	360



French Type Monophase Rubber Series 1x16A. (2P+E) 200/250V.

Product Code	Description	IP	Box	Pack
BK1-1402-2031	Straight Plug French Type	IP44	30	540
BK1-1402-2361	Connector Socket French Type	IP44	25	300
BK1-1402-3622	2way Socket French Type	IP54	8	144
BK1-1402-3623	3way Socket French Type	IP54	7	126
BK1-1402-3624	4way Socket French Type	IP54	8	96



UPS Monophase Rubber 1x16A. (2P+E) 200/250V.

Product Code	Description	IP	Box	Pack
BK1-1402-2031	UPS Straight Plug	IP44	30	540
BK1-1402-2042	UPS Angled Plug	IP44	20	360
BK1-1402-2041	UPS Handle Angled Plug	IP44	20	360



CARAVAN TYPE PRODUCTS



IP54



CARAVAN TYPE
ENERGY TRANSFER UNIT
OFF VIEW



BKT-0500-3000 (ABS)
3/16A. 220V. socket with cover



BKT-0002-3001 (ABS)
LIGHTER + SATELLITE
INPUT



BKT-3000-3000 (ABS)
Empty



BKT-0106-2000
(Poliamid 6)
1/16A. Plug - 3/16A. ADAPTER
SOCKET



BKT-0502-2000
(Poliamid 6)
3/16A. Plug - 1/16A. ADAPTER
SOCKET



BC1-1402-2870
(Poliamid 6)
3/16A. 220V.

Our cable mobile extension products are suitable for use in camping, boats and caravans.



Our range designed for camping, caravan and general mobile energy transfer. 100% test by applying lugs on TSE certified cable connections with the assurance of Bemis controlled production

Purpose: The need for such products has increased due to the increase in technical man hour wages. It has been added to our list to meet this need.

Product Code	Description	IP	Box	Pack
BV2-1402-3511	Surface Mounted Socket (Blue)	IP54	12	216
BV3-1402-3511	Surface Mounted Socket (Yellow)	IP54	12	216
BV2-1402-3612	2way Socket (Blue)	IP54	8	144
BV3-1402-3612	2way Socket (Yellow)	IP54	8	144
BV1-1402-3613	3way Socket (Green)	IP54	7	126
BV2-1402-3613	3way Socket (Blue)	IP54	7	126
BV3-1402-3613	3way Socket (Yellow)	IP54	7	126
BV4-1402-3613	3way Socket (Orange)	IP54	7	126
BV5-1402-3613	3way Socket (Grey)	IP54	7	126
BV6-1402-3613	3way Socket (Red)	IP54	7	126
BV2-1402-3614	4way Socket (Blue)	IP54	8	96
BV3-1402-3614	4way Socket (Yellow)	IP54	8	96



Product Code	Description	IP	Box	Pack
BV1-1402-2011	Straight Plug (Green)	IP44	30	540
BV2-1402-2011	Straight Plug (Blue)	IP44	30	540
BV3-1402-2011	Straight Plug (Yellow)	IP44	30	540
BV4-1402-2011	Straight Plug (Orange)	IP44	30	540
BV5-1402-2011	Straight Plug (Grey)	IP44	30	540
BV6-1402-2011	Straight Plug (Red)	IP44	30	540



Product Code	Description	IP	Box	Pack
BV1-1402-2311	Connector Socket (Green)	IP44	25	300
BV2-1402-2311	Connector Socket (Blue)	IP44	25	300
BV3-1402-2311	Connector Socket (Yellow)	IP44	25	300
BV4-1402-2311	Connector Socket (Orange)	IP44	25	300
BV5-1402-2311	Connector Socket (Grey)	IP44	25	300
BV6-1402-2311	Connector Socket (Red)	IP44	25	300



Note: Color products are produced to order

Colorful Monophase Rubber Handle Angled Plug 1x16A. (2P+E) 200/250V.

Product Code	Description	IP	Box	Pack
BV1-1402-2021	Handle Angled Plug (Green)	IP44	20	360
BV2-1402-2021	Handle Angled Plug (Blue)	IP44	20	360
BV3-1402-2021	Handle Angled Plug (Yellow)	IP44	20	360
BV4-1402-2021	Handle Angled Plug (Orange)	IP44	20	360
BV5-1402-2021	Handle Angled Plug (Grey)	IP44	20	360
BV6-1402-2021	Handle Angled Plug (Red)	IP44	20	360

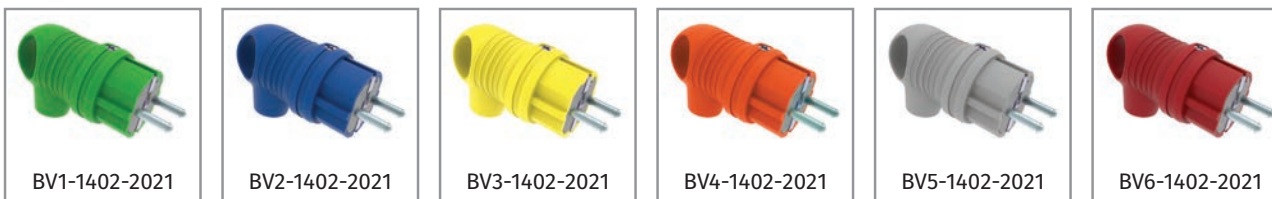

UPS Colorful Monophase Rubber 1x16A. (2P+E) 200/250V.

Product Code	Description	IP	Box	Pack
BV1-1402-2031	UPS Straight Plug (Green)	IP44	30	540
BV2-1402-2031	UPS Straight Plug (Blue)	IP44	30	540
BV3-1402-2031	UPS Straight Plug (Yellow)	IP44	30	540
BV4-1402-2031	UPS Straight Plug (Orange)	IP44	30	540
BV5-1402-2031	UPS Straight Plug (Grey)	IP44	30	540
BV6-1402-2031	UPS Straight Plug (Red)	IP44	30	540

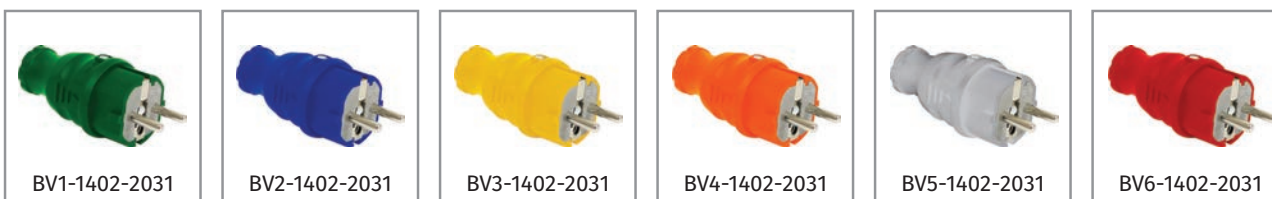

UPS Colorful Monophase Rubber Handle Angled Plug 1x16A. (2P+E) 200/250V.

Product Code	Description	IP	Box	Pack
BV1-1402-2041	UPS Handle Angled Plug (Green)	IP44	20	360
BV2-1402-2041	UPS Handle Angled Plug (Blue)	IP44	20	360
BV3-1402-2041	UPS Handle Angled Plug (Yellow)	IP44	20	360
BV4-1402-2041	UPS Handle Angled Plug (Orange)	IP44	20	360
BV5-1402-2041	UPS Handle Angled Plug (Grey)	IP44	20	360
BV6-1402-2041	UPS Handle Angled Plug (Red)	IP44	20	360



Note: Color products are produced to order



Product Code	Description	IP	Box	Pack
BP1-1402-2011	Straight Plug	IP44	35	630
BP1-1402-1311	Connector Socket	IP20	20	360
BP1-1402-2022	Angled Plug	IP44	35	630

Product Code	Description	IP	Box	Pack
BY8-1402-2440	Screwless Panel Socket	IP44	30	540
BY8-1402-2700	Panel Socket (Horizontal Input)	IP44	30	540
BY8-1402-2705	Panel Socket (French - Horizontal Input)	IP44	30	540
BY8-1402-3510	Schuko Socket with Wall Cover	IP44	12	216
BY5-1402-2700	Panel Socket (Grey)	IP44	30	540
BY9-1402-2700	Panel Socket (Black)	IP44	30	540
BY8-1402-2720	UPS Panel Socket (Yellow)	IP44	30	540
BP1-1402-2510	Surface Mounted Socket	IP44	6	108
BY8-1402-3700	Panel Socket	IP54	25	450
BY9-1402-3700	Panel Socket (Black)	IP54	25	450
BY3-1402-3700	Panel Socket (Yellow)	IP54	25	450
BP1-1402-2410	Panel Mounted Socket	IP44	18	216

Product Code	Description	IP	Box	Pack
BP1-1402-2013	Straight Plug	IP44	10	180
BP1-1402-2311	Connector Socket with Cover	IP44	10	180
BP1-1402-2413	Panel Mounted Socket (Small Cover)	IP44	10	180
BP1-1402-2512	Surface Mounted Socket	IP44	6	108
BP1-1402-2535	90° Angled Surface Socket	IP44	4	72

Product Code	Description	IP	Box	Pack
BR1-1402-2711	Rail Socket	IP20	12	216
BR1-1402-2712	Rail Socket with Led	IP20	12	216
BR1-1402-2713	Rail Socket with French	IP20	12	216
BR1-1402-2714	Rail Socket French with Led	IP20	12	216

Product Code	Description	IP	Box	Pack
BP1-1402-2031	UPS Straight Plug	IP44	35	630
BP1-1402-2042	UPS Angled Plug	IP44	35	630
BY2-1402-2011	Straight Plug (Blue)	IP44	35	630
BY2-1402-2031	UPS Straight Plug (Blue)	IP44	35	630
BY5-1402-2011	Straight Plug (Grey)	IP44	35	630
BY5-1402-2031	UPS Straight Plug (Grey)	IP44	35	630
BY2-1402-2022	Angled Plug (Blue)	IP44	35	630
BY2-1402-2042	UPS Angled Plug (Blue)	IP44	35	630

Note: Color products are produced to order

Plastic Monophase Series

1x16A. (2P+E) 200/250V.

	Product Code	Description	IP	Box	Pack
Brand New	BY8-1402-2446	Quick Connect Screwless Panel Socket	IP44	30	540
Brand New	BY8-1402-2447	French Type Quick Connect Screwless Panel Socket	IP44	30	540
Brand New	BY8-1402-2476	Quick Connect Screwless Panel Socket (with child protection)	IP44	30	540
Brand New	BY8-1402-2477	French Type Quick Connect Screwless Panel Socket (with child protection)	IP44	30	540



Rubber Arc Weld

200A-400A



Product Code	Description	IP	Box	Pack
BK4-7501-2010	16/95mm ² 200A. Plug	IP55	15	180
BK4-7501-2310	16/95mm ² 200A. Connector Socket	IP55	15	180
BK4-7501-2410	16/95mm ² 200A. Panel Mounted Socket	IP55	12	216
BK4-9501-2010	50/150mm ² 400A. Plug	IP55	15	180
BK4-9501-2310	50/150mm ² 400A. Connector Socket	IP55	15	180
BK4-9501-2410	50/150mm ² 400A. Panel Mounted Socket	IP55	12	216



Bemis products are preferred due to their ease of assembly. All 90° Angled Surface with Monophase Panel Socket
Our sockets have been wired and assembled to the terminal, this application is 16A. / 32A. / 63A. / 125A. / 160A.
It is applied to all of our wall sockets.

IP44

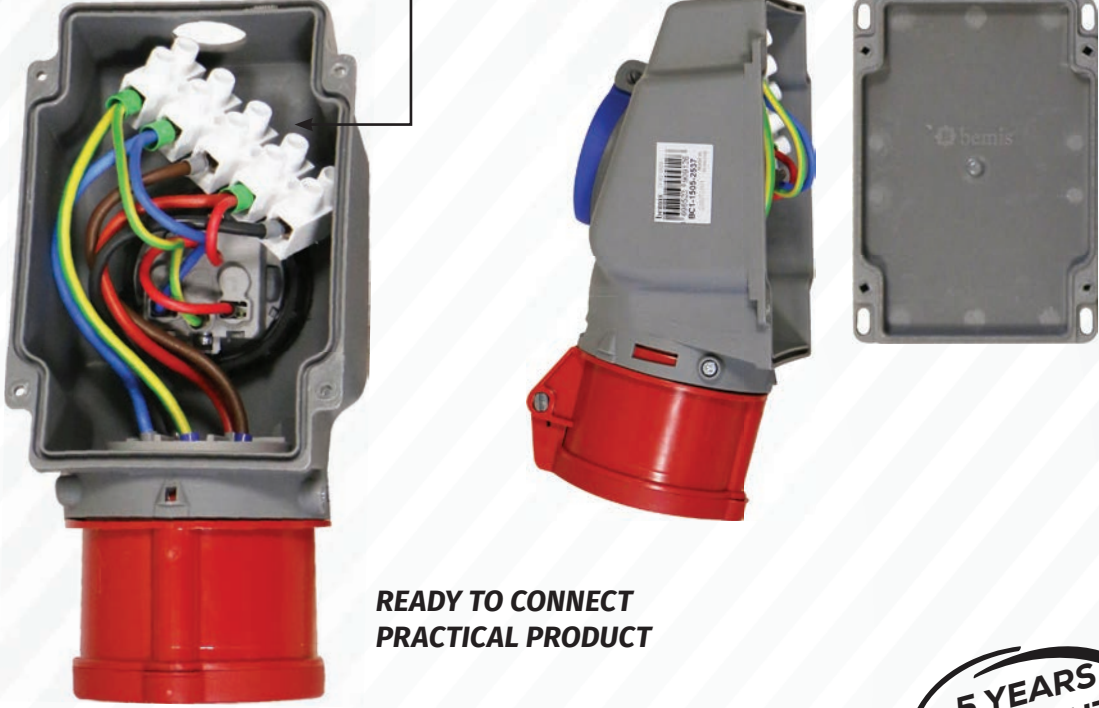

**READY TO CONNECT
PRACTICAL PRODUCT**

**5 YEARS
WARRANTY**

IP67

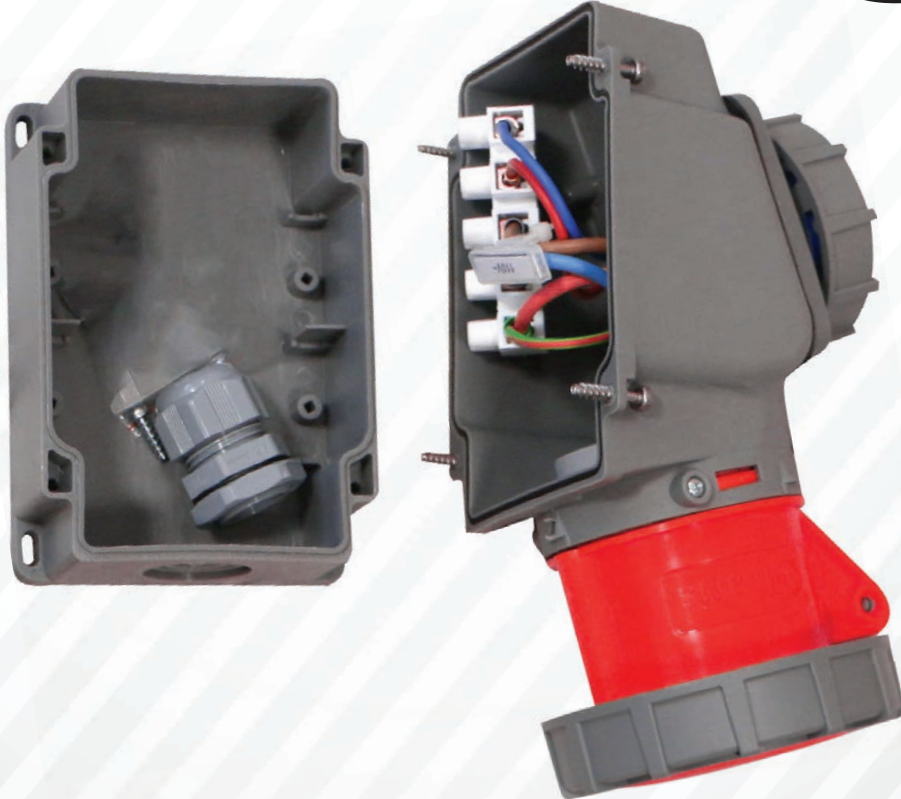

5 YEARS
WARRANTY

CEE Norm Plug and Socket Series

16A - 32A - 63A - 125A - 160A

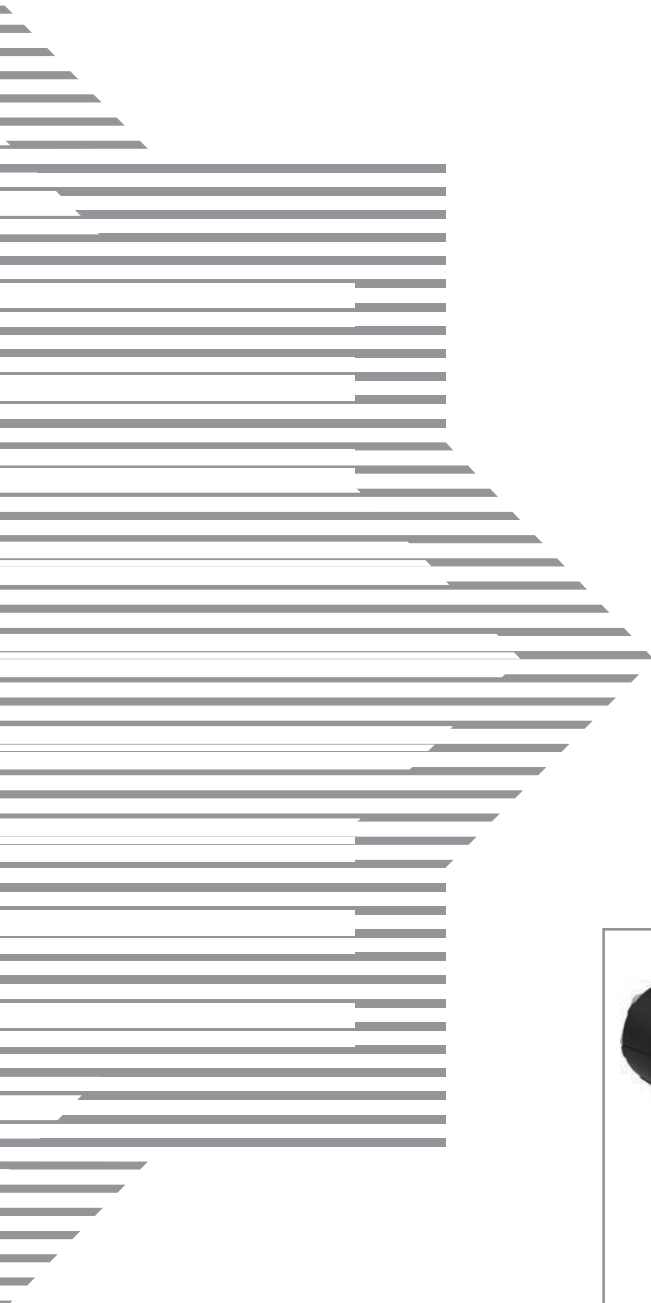



Product Code	Description	IP	Box	Pack
BC1-1303-2011	3/16A. Straight Plug	IP44	10	180
BC1-1303-2312	3/16A. Connector Socket	IP44	10	180
BC1-1303-2413	3/16A. Panel Mounted Socket	IP44	15	180
BC1-1303-2114	3/16A. Panel Mounted Plug	IP44	10	180
BC1-1303-2130	3/16A. 90° Angled Rotate Plug	IP44	6	108
BC1-1303-2210	3/16A. Surface Mounted Plug	IP44	6	108
BC1-1303-2236	3/16A. 90° Angled Surface Plug	IP44	6	72
BC1-1303-2235	3/16A. 90° Angled Surface Plug with Cover	IP44	6	72
BC1-1303-2420	3/16A. 45° Angled Panel Mounted Socket	IP44	8	144
BC1-1303-2510	3/16A. Surface Mounted Socket	IP44	6	108
BC1-1303-2535	3/16A. 90° Angled Surface Socket	IP44	3	54

Product Code	Description	IP	Box	Pack
BC1-1303-7011	3/16A. Straight Plug	IP67	8	144
BC1-1303-7312	3/16A. Connector Socket	IP67	8	144
BC1-1303-7413	3/16A. Panel Mounted Socket	IP67	8	144
BC1-1303-7114	3/16A. Panel Mounted Plug	IP67	10	180
BC1-1303-7210	3/16A. Surface Mounted Plug	IP67	4	72
BC1-1303-7236	3/16A. 90° Angled Surface Plug	IP67	3	54
BC1-1303-7420	3/16A. 45° Angled Panel Mounted Socket	IP67	6	108
BC1-1303-7510	3/16A. Surface Mounted Socket	IP67	4	72
BC1-1303-7535	3/16A. 90° Angled Surface Socket	IP67	3	54



3/16A. (2P+E)
 220V. 50/60 Hz. 6h
 (Poliamid 6)



Product Code	Description	IP	Box	Pack
BC1-1403-2011	3/16A. Straight Plug	IP44	10	180
BC1-1403-2312	3/16A. Connector Socket	IP44	10	180
BC1-1403-2413	3/16A. Panel Mounted Socket	IP44	15	180
BC1-1403-2114	3/16A. Panel Mounted Plug	IP44	10	180
BC1-1403-2130	3/16A. 90° Angled Rotate Plug	IP44	6	108
BC1-1403-2210	3/16A. Surface Mounted Plug	IP44	6	108
BC1-1403-2236	3/16A. 90° Angled Surface Plug	IP44	6	72
BC1-1403-2235	3/16A. 90° Angled Surface Plug with Cover	IP44	6	72
BC1-1403-2535	3/16A. 90° Angled Surface Socket	IP44	3	54
BC1-1403-2420	3/16A. 45° Angled Panel Mounted Socket	IP44	8	144
BC1-1403-2510	Surface Mounted Socket	IP44	6	108



Product Code	Description	IP	Box	Pack
BC1-1403-7011	3/16A. Straight Plug	IP67	8	144
BC1-1403-7312	3/16A. Connector Socket	IP67	8	144
BC1-1403-7413	3/16A. Panel Mounted Socket	IP67	8	144
BC1-1403-7114	3/16A. Panel Mounted Plug	IP67	10	180
BC1-1403-7210	3/16A. Surface Mounted Plug	IP67	4	72
BC1-1403-7236	3/16A. 90° Angled Surface Plug	IP67	3	54
BC1-1403-7420	3/16A. 45° Angled Panel Mounted Socket	IP67	6	108
BC1-1403-7510	3/16A. Surface Mounted Socket	IP67	4	72
BC1-1403-7535	3/16A. 90° Angled Surface Socket	IP67	3	54





Product Code	Description	IP	Box	Pack
BC1-1504-2011	4/16A. Straight Plug	IP44	8	144
BC1-1504-2312	4/16A. Connector Socket	IP44	8	144
BC1-1504-2413	4/16A. Panel Mounted Socket	IP44	15	180
BC1-1504-2114	4/16A. Panel Mounted Plug	IP44	10	180
BC1-1504-2130	4/16A. 90° Angled Rotate Plug	IP44	6	108
BC1-1504-2210	4/16A. Surface Mounted Plug	IP44	6	108
BC1-1504-2236	4/16A. 90° Angled Surface Plug	IP44	6	72
BC1-1504-2235	4/16A. 90° Angled Surface Plug with Cover	IP44	6	72
BC1-1504-2535	4/16A. 90° Angled Surface Socket	IP44	3	54
BC1-1504-2420	4/16A. 45° Angled Panel Mounted Socket	IP44	8	144
BC1-1504-2510	4/16A. Surface Mounted Socket	IP44	6	108
BR1-1504-2711	Rail Socket	IP20	6	108

Product Code	Description	IP	Box	Pack
BC1-1504-7011	4/16A. Straight Plug	IP67	6	108
BC1-1504-7312	4/16A. Connector Socket	IP67	6	108
BC1-1504-7413	4/16A. Panel Mounted Socket	IP67	6	108
BC1-1504-7114	4/16A. Panel Mounted Plug	IP67	10	180
BC1-1504-7210	4/16A. Surface Mounted Plug	IP67	4	72
BC1-1504-7236	4/16A. 90° Angled Surface Plug	IP67	3	54
BC1-1504-7420	4/16A. 45° Angled Panel Mounted Socket	IP67	6	108
BC1-1504-7510	4/16A. Surface Mounted Socket	IP67	4	72
BC1-1504-7535	4/16A. 90° Angled Surface Socket	IP67	3	54



CEE Norm Series



5/16A. (3P+E+N)

380V. 50/60 Hz. 6h
(Poliamid 6)



Product Code	Description	IP	Box	Pack
BC1-1505-2011	5/16A. Straight Plug	IP44	8	144
BC1-1505-2312	5/16A. Connector Socket	IP44	8	144
BC1-1505-2413	5/16A. Panel Mounted Socket (75x75)	IP44	15	180
BC1-1505-2114	5/16A. Panel Mounted Plug	IP44	8	144
BC1-1505-2140	5/16A. Screwless Connection Plug	IP44	8	96
BC1-1505-2130	5/16A. 90° Angled Rotate Plug	IP44	6	108
BC1-1505-2210	5/16A. Surface Mounted Plug	IP44	6	108
BC1-1505-2236	5/16A. 90° Angled Surface Plug	IP44	3	54
BC1-1505-2235	5/16A. 90° Angled Surface Plug with Cover	IP44	3	54
BC1-1505-2238	5/16A. 90° Angled Surface Plug with Schuko	IP44	3	36
BC1-1505-2240	5/16A. Pako Switch 90° Angled Surface Plug	IP44	1	18
BC1-1505-2420	5/16A. 45° Angled Panel Mounted Socket	IP44	6	108
BC1-1505-2440	5/16A. Screwless Connection Socket	IP44	8	96
BC1-1505-2510	5/16A. Surface Mounted Socket	IP44	6	108
BC1-1505-2535	5/16A. 90° Angled Surface Socket	IP44	3	54
BC1-1505-2537	5/16A. 90° Angled Surface Socket with Schuko	IP44	3	36
BC1-1505-2550	5/16A. 90° Angled Surface Socket with Pako Switch	IP44	1	18
BC1-1505-2050	5/16A. Inverter Straight Plug	IP44	8	96
BC1-1505-2070	5/16A. Inverter Panel Mounted Plug	IP44	8	144
BC1-1505-2080	5/16A. 90° Angled Inverter Rotate Plug	IP44	6	108
BC1-1505-2060	5/16A. 90° Angled Inverter Surface Plug	IP44	3	54
BC1-1505-2061	5/16A. 90° Angled Inverter Surface Plug with Cover	IP44	3	54
BR1-1505-2711	5/16A. Rail Socket	IP20	6	108

Brand New

Brand New



Product Code	Description	IP	Box	Pack
BC1-1505-7011	5/16A. Straight Plug	IP67	4	72
BC1-1505-7312	5/16A. Connector Socket	IP67	4	72
BC1-1505-7413	5/16A. Panel Mounted Socket (75x75)	IP67	6	108
BC1-1505-7114	5/16A. Panel Mounted Plug (83x90)	IP67	6	108
BC1-1505-7210	5/16A. Surface Mounted Plug	IP67	4	72
BC1-1505-7236	5/16A. 90° Angled Surface Plug	IP67	3	54
BC1-1505-7238	5/16A. 90° Angled Surface Plug with Schuko	IP67	1	18
BC1-1505-7420	5/16A. 45° Angled Panel Mounted Socket	IP67	6	108
BC1-1505-7440	5/16A. Screwless Connection Socket	IP67	6	108
BC1-1505-7510	5/16A. Surface Mounted Socket	IP67	4	72
BC1-1505-7535	5/16A. 90° Angled Surface Socket	IP67	3	54
BC1-1505-7537	5/16A. 90° Angled Surface Socket with Schuko	IP67	1	18
BC1-1505-7050	5/16A. Inverter Straight Plug	IP67	4	72
BC1-1505-7070	5/16A. Inverter Panel Mounted Plug	IP67	6	108
BC1-1505-7060	5/16A. 90° Angled Inverter Surface Plug	IP67	3	54

Brand New

Brand New





Product Code	Description	IP	Box	Pack
BC1-3303-2011	3/32A. Straight Plug	IP44	8	96
BC1-3303-2312	3/32A. Connector Socket	IP44	8	96
BC1-3303-2413	3/32A. Panel Mounted Socket (75x75)	IP44	8	96
BC1-3303-2114	3/32A. Panel Mounted Plug	IP44	8	144
BC1-3303-2140	3/32A. Screwless Connection Plug	IP44	8	96
BC1-3303-2130	3/32A. 90° Angled Rotate Plug	IP44	6	108
BC1-3303-2210	3/32A. Surface Mounted Plug	IP44	6	108
BC1-3303-2236	3/32A. 90° Angled Surface Plug	IP44	3	54
BC1-3303-2235	3/32A. 90° Angled Surface Plug with Cover	IP44	3	54
BC1-3303-2238	3/32A. 90° Angled Surface Plug with Schuko	IP44	3	36
BC1-3303-2240	3/32A. Pako Switch 90° Angled Surface Plug	IP44	1	18
BC1-3303-2440	3/32A. Screwless Connection Socket	IP44	8	96
BC1-3303-2510	3/32A. Surface Mounted Socket	IP44	6	108
BC1-3303-2535	3/32A. 90° Angled Surface Socket	IP44	3	54
BC1-3303-2537	3/32A. 90° Angled Surface Socket with Schuko	IP44	3	36
BC1-3303-2550	3/32A. 90° Angled Surface Socket with Pako Switch	IP44	1	18

Brand New

Brand New

Product Code	Description	IP	Box	Pack
BC1-3303-7011	3/32A. Straight Plug	IP67	3	54
BC1-3303-7312	3/32A. Connector Socket	IP67	3	54
BC1-3303-7413	3/32A. Panel Mounted Socket (75x75)	IP67	4	72
BC1-3303-7114	3/32A. Panel Mounted Plug (83x90)	IP67	6	108
BC1-3303-7210	3/32A. Surface Mounted Plug	IP67	2	24
BC1-3303-7236	3/32A. 90° Angled Surface Plug	IP67	3	54
BC1-3303-7238	3/32A. 90° Angled Surface Plug with Schuko	IP67	1	18
BC1-3303-7440	3/32A. Screwless Connection Socket	IP67	4	72
BC1-3303-7510	3/32A. Surface Mounted Socket	IP67	2	36
BC1-3303-7535	3/32A. 90° Angled Surface Socket	IP67	3	54
BC1-3303-7537	3/32A. 90° Angled Surface Socket with Schuko	IP67	1	18



3/32A. (2P+E)

220V. 50/60 Hz. 6h
(Poliamid 6)



Product Code	Description	IP	Box	Pack
BC1-3403-2011	3/32A. Straight Plug	IP44	8	96
BC1-3403-2312	3/32A. Connector Socket	IP44	8	96
BC1-3403-2413	3/32A. Panel Mounted Socket (75x75)	IP44	8	96
BC1-3403-2114	3/32A. Panel Mounted Plug	IP44	8	144
BC1-3403-2140	3/32A. Screwless Connection Plug	IP44	8	96
BC1-3403-2130	3/32A. 90° Angled Rotate Plug	IP44	6	108
BC1-3403-2210	3/32A. Surface Mounted Plug	IP44	6	108
BC1-3403-2236	3/32A. 90° Angled Surface Plug	IP44	3	54
BC1-3403-2235	3/32A. 90° Angled Surface Plug with Cover	IP44	3	54
BC1-3403-2238	3/32A. 90° Angled Surface Plug with Schuko	IP44	3	36
BC1-3403-2240	3/32A. Pako Switch 90° Angled Surface Plug	IP44	1	18
BC1-3403-2420	3/32A. 45° Angled Panel Mounted Socket	IP44	4	72
BC1-3403-2440	3/32A. Screwless Connection Socket	IP44	8	96
BC1-3403-2510	3/32A. Surface Mounted Socket	IP44	6	108
BC1-3403-2535	3/32A. 90° Angled Surface Socket	IP44	3	54
BC1-3403-2537	3/32A. 90° Angled Surface Socket with Schuko	IP44	3	36
BC1-3403-2550	3/32A. 90° Angled Surface Socket with Pako Switch	IP44	1	18

Brand New

Brand New



Product Code	Description	IP	Box	Pack
BC1-3403-7011	3/32A. Straight Plug	IP67	3	54
BC1-3403-7312	3/32A. Connector Socket	IP67	3	54
BC1-3403-7413	3/32A. Panel Mounted Socket (75x75)	IP67	4	72
BC1-3403-7114	3/32A. Panel Mounted Plug (83x90)	IP67	6	108
BC1-3403-7210	3/32A. Surface Mounted Plug	IP67	2	24
BC1-3403-7236	3/32A. 90° Angled Surface Plug	IP67	3	54
BC1-3403-7238	3/32A. 90° Angled Surface Plug with Schuko	IP67	1	18
BC1-3403-7420	3/32A. 45° Angled Panel Mounted Socket	IP67	4	72
BC1-3403-7440	3/32A. Screwless Connection Socket	IP67	4	72
BC1-3403-7510	3/32A. Surface Mounted Socket	IP67	2	36
BC1-3403-7535	3/32A. 90° Angled Surface Socket	IP67	3	54
BC1-3403-7537	3/32A. 90° Angled Surface Socket with Schuko	IP67	1	18





Product Code	Description	IP	Box	Pack
BC1-3504-2011	4/32A. Straight Plug	IP44	8	96
BC1-3504-2312	4/32A. Connector Socket	IP44	8	96
BC1-3504-2413	4/32A. Panel Mounted Socket (75x75)	IP44	8	96
BC1-3504-2114	4/32A. Panel Mounted Plug	IP44	8	144
BC1-3504-2140	4/32A. Screwless Connection Plug	IP44	8	96
BC1-3504-2130	4/32A. 90° Angled Rotate Plug	IP44	6	108
BC1-3504-2210	4/32A. Surface Mounted Plug	IP44	6	108
BC1-3504-2236	4/32A. 90° Angled Surface Plug	IP44	3	54
BC1-3504-2235	4/32A. 90° Angled Surface Plug with Cover	IP44	3	54
BC1-3504-2238	4/32A. 90° Angled Surface Plug with Schuko	IP44	3	36
BC1-3504-2240	4/32A. pako Switch 90° Angled Surface Plug	IP44	1	18
BC1-3504-2420	4/32A. 45° Angled Panel Mounted Socket	IP44	4	72
BC1-3504-2440	4/32A. Screwless Connection Socket	IP44	8	96
BC1-3504-2510	4/32A. Surface Mounted Socket	IP44	6	108
BC1-3504-2535	4/32A. 90° Angled Surface Socket	IP44	3	54
BC1-3504-2537	4/32A. 90° Angled Surface Socket with Schuko	IP44	3	36
BC1-3504-2550	4/32A. 90° Angled Surface Socket with pako Switch	IP44	1	18

Brand New

Brand New

Product Code	Description	IP	Box	Pack
BC1-3504-7011	4/32A. Straight Plug	IP67	3	54
BC1-3504-7312	4/32A. Connector Socket	IP67	3	54
BC1-3504-7413	4/32A. Panel Mounted Socket (75x75)	IP67	4	72
BC1-3504-7114	4/32A. Panel Mounted Plug (83x90)	IP67	6	108
BC1-3504-7210	4/32A. Surface Mounted Plug	IP67	2	24
BC1-3504-7236	4/32A. 90° Angled Surface Plug	IP67	3	54
BC1-3504-7238	4/32A. 90° Angled Surface Plug with Schuko	IP67	1	18
BC1-3504-7420	4/32A. 45° Angled Panel Mounted Socket	IP67	4	72
BC1-3504-7440	4/32A. Screwless Connection Socket	IP67	4	72
BC1-3504-7510	4/32A. Surface Mounted Socket	IP67	2	36
BC1-3504-7535	4/32A. 90° Angled Surface Socket	IP67	3	54
BC1-3504-7537	4/32A. 90° Angled Surface Socket with Schuko	IP67	1	18

3h CEE Norm series can be produced optionally

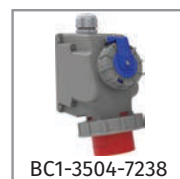

CEE Norm Series



5/32A. (3P+E+N)

380V. 50/60 Hz. 6h

(Poliamid 6)



Product Code	Description	IP	Box	Pack
BC1-3505-2011	5/32A. Straight Plug	IP44	8	96
BC1-3505-2312	5/32A. Connector Socket	IP44	8	96
BC1-3505-2413	5/32A. Panel Mounted Socket (75x75)	IP44	8	96
BC1-3505-2114	5/32A. Panel Mounted Plug	IP44	8	144
BC1-3505-2140	5/32A. Screwless Connection Plug	IP44	8	96
BC1-3505-2130	5/32A. 90° Angled Rotate Plug	IP44	6	108
BC1-3505-2210	5/32A. Surface Mounted Plug	IP44	6	108
BC1-3505-2236	5/32A. 90° Angled Surface Plug	IP44	3	54
BC1-3505-2235	5/32A. 90° Angled Surface Plug with Cover	IP44	3	54
BC1-3505-2238	5/32A. 90° Angled Surface Plug with Schuko	IP44	3	36
BC1-3505-2240	5/32A. Pako Switch 90° Angled Surface Plug	IP44	1	18
BC1-3505-2420	5/32A. 45° Angled Panel Mounted Socket	IP44	6	108
BC1-3505-2440	5/32A. Screwless Connection Socket	IP44	8	96
BC1-3505-2510	5/32A. Surface Mounted Socket	IP44	6	108
BC1-3505-2535	5/32A. 90° Angled Surface Socket	IP44	3	54
BC1-3505-2537	5/32A. 90° Angled Surface Socket with Schuko	IP44	3	36
BC1-3505-2550	5/32A. 90° Angled Surface Socket with Pako Switch	IP44	1	18
BC1-3505-2050	5/32A. Inverter Straight Plug	IP44	8	96
BC1-3505-2070	5/32A. Inverter Panel Mounted Plug	IP44	8	144
BC1-3505-2080	5/32A. 90° Angled Inverter Rotate Plug	IP44	6	108
BC1-3505-2060	5/32A. 90° Angled Inverter Surface Plug	IP44	3	54
BC1-3505-2061	5/32A. 90° Angled Inverter Surface Plug with Cover	IP44	3	54

Brand New

Brand New



Brand New

Brand New

Product Code	Description	IP	Box	Pack
BC1-3505-7011	5/32A. Straight Plug	IP67	3	54
BC1-3505-7312	5/32A. Connector Socket	IP67	3	54
BC1-3505-7413	5/32A. Panel Mounted Socket (75x75)	IP67	4	72
BC1-3505-7114	5/32A. Panel Mounted Plug (83x90)	IP67	6	108
BC1-3505-7210	5/32A. Surface Mounted Plug	IP67	2	24
BC1-3505-7236	5/32A. 90° Angled Surface Plug	IP67	3	54
BC1-3505-7238	5/32A. 90° Angled Surface Plug with Schuko	IP67	1	18
BC1-3505-7420	5/32A. 45° Angled Panel Mounted Socket	IP67	4	72
BC1-3505-7440	5/32A. Screwless Connection Socket	IP67	4	72
BC1-3505-7510	5/32A. Surface Mounted Socket	IP67	2	36
BC1-3505-7535	5/32A. 90° Angled Surface Socket	IP67	3	54
BC1-3505-7537	5/32A. 90° Angled Surface Socket with Schuko	IP67	1	18
BC1-3505-7050	5/32A. Inverter Straight Plug	IP67	3	54
BC1-3505-7070	5/32A. Inverter Panel Mounted Plug	IP67	6	108
BC1-3505-7060	5/32A. 90° Angled Inverter Surface Plug	IP67	3	54

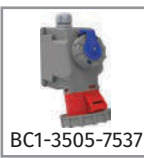



Product Code	Description	IP	Box	Pack
BC1-4303-2011	3/63A. Straight Plug	IP44	1	12
BC1-4303-2312	3/63A. Connector Socket	IP44	1	12
BC1-4303-2413	3/63A. Panel Mounted Socket	IP44	1	24
BC1-4303-2114	3/63A. Panel Mounted Plug	IP44	1	24
BC1-4303-2420	3/63A. 45° Angled Panel Mounted Socket	IP44	1	24
BC1-4303-2510	3/63A. Surface Mounted Socket	IP44	1	12
BC1-4303-2535	3/63A. 90° Angled Surface Socket	IP44	1	7
BC1-4303-2537	3/63A. 90° Angled Surface Socket with Schuko	IP44	1	7
BC1-4303-2210	3/63A. Surface Mounted Plug	IP44	1	12
BC1-4303-2236	3/63A. 90° Angled Surface Plug	IP44	1	7
BC1-4303-2238	3/63A. 90° Angled Surface Plug with Schuko	IP44	1	7

Product Code	Description	IP	Box	Pack
BC1-4303-7011	3/63A. Straight Plug	IP67	1	12
BC1-4303-7312	3/63A. Connector Socket	IP67	1	12
BC1-4303-7413	3/63A. Panel Mounted Socket	IP67	1	24
BC1-4303-7114	3/63A. Panel Mounted Plug	IP67	1	24
BC1-4303-7420	3/63A. 45° Angled Panel Mounted Socket	IP67	1	24
BC1-4303-7510	3/63A. Surface Mounted Socket	IP67	1	12
BC1-4303-7535	3/63A. 90° Angled Surface Socket	IP67	1	7
BC1-4303-7537	3/63A. 90° Angled Surface Socket with Schuko	IP67	1	7
BC1-4303-7210	3/63A. Surface Mounted Plug	IP67	1	12
BC1-4303-7236	3/63A. 90° Angled Surface Plug	IP67	1	7
BC1-4303-7238	3/63A. 90° Angled Surface Plug with Schuko	IP67	1	7



3/63A. (2P+E)
 220V. 50/60 Hz. 6h
 (Poliamid 6)



Product Code	Description	IP	Box	Pack
BC1-4403-2011	3/63A. Straight Plug	IP44	1	12
BC1-4403-2312	3/63A. Connector Socket	IP44	1	12
BC1-4403-2413	3/63A. Panel Mounted Socket	IP44	1	24
BC1-4403-2114	3/63A. Panel Mounted Plug	IP44	1	24
BC1-4403-2420	3/63A. 45° Angled Panel Mounted Socket	IP44	1	24
BC1-4403-2510	3/63A. Surface Mounted Socket	IP44	1	12
BC1-4403-2535	3/63A. 90° Angled Surface Socket	IP44	1	7
BC1-4403-2537	3/63A. 90° Angled Surface Socket with Schuko	IP44	1	7
BC1-4403-2210	3/63A. Surface Mounted Plug	IP44	1	12
BC1-4403-2236	3/63A. 90° Angled Surface Plug	IP44	1	7
BC1-4403-2238	3/63A. 90° Angled Surface Plug with Schuko	IP44	1	7



Product Code	Description	IP	Box	Pack
BC1-4403-7011	3/63A. Straight Plug	IP67	1	12
BC1-4403-7312	3/63A. Connector Socket	IP67	1	12
BC1-4403-7413	3/63A. Panel Mounted Socket	IP67	1	24
BC1-4403-7114	3/63A. Panel Mounted Plug	IP67	1	24
BC1-4403-7420	3/63A. 45° Angled Panel Mounted Socket	IP67	1	24
BC1-4403-7510	3/63A. Surface Mounted Socket	IP67	1	12
BC1-4403-7535	3/63A. 90° Angled Surface Socket	IP67	1	7
BC1-4403-7537	3/63A. 90° Angled Surface Socket with Schuko	IP67	1	7
BC1-4403-7210	3/63A. Surface Mounted Plug	IP67	1	12
BC1-4403-7236	3/63A. 90° Angled Surface Plug	IP67	1	7
BC1-4403-7238	3/63A. 90° Angled Surface Plug with Schuko	IP67	1	7





4/63A. (3P+E)
 380V. 50/60 Hz. 6h
 (Poliamid 6)



Product Code	Description	IP	Box	Pack
BC1-4504-2011	4/63A. Straight Plug	IP44	1	12
BC1-4504-2312	4/63A. Connector Socket	IP44	1	12
BC1-4504-2413	4/63A. Panel Mounted Socket	IP44	1	24
BC1-4504-2114	4/63A. Panel Mounted Plug	IP44	1	24
BC1-4504-2420	4/63A. 45° Angled Panel Mounted Socket	IP44	1	24
BC1-4504-2510	4/63A. Surface Mounted Socket	IP44	1	12
BC1-4504-2535	4/63A. 90° Angled Surface Socket	IP44	1	7
BC1-4504-2537	4/63A. 90° Angled Surface Socket with Schuko	IP44	1	7
BC1-4504-2210	4/63A. Surface Mounted Plug	IP44	1	12
BC1-4504-2236	4/63A. 90° Angled Surface Plug	IP44	1	7
BC1-4504-2238	4/63A. 90° Angled Surface Plug with Schuko	IP44	1	7

Product Code	Description	IP	Box	Pack
BC1-4504-7011	4/63A. Straight Plug	IP67	1	12
BC1-4504-7312	4/63A. Connector Socket	IP67	1	12
BC1-4504-7413	4/63A. Panel Mounted Socket	IP67	1	24
BC1-4504-7114	4/63A. Panel Mounted Plug	IP67	1	24
BC1-4504-7420	4/63A. 45° Angled Panel Mounted Socket	IP67	1	24
BC1-4504-7510	4/63A. Surface Mounted Socket	IP67	1	12
BC1-4504-7535	4/63A. 90° Angled Surface Socket	IP67	1	7
BC1-4504-7537	4/63A. 90° Angled Surface Socket with Schuko	IP67	1	7
BC1-4504-7210	4/63A. Surface Mounted Plug	IP67	1	12
BC1-4504-7236	4/63A. 90° Angled Surface Plug	IP67	1	7
BC1-4504-7238	4/63A. 90° Angled Surface Plug with Schuko	IP67	1	7





5/63A. (3P+E+N)
380V. 50/60 Hz. 6h
(Poliamid 6)



Product Code	Description	IP	Box	Pack
BC1-4505-2011	5/63A. Straight Plug	IP44	1	12
BC1-4505-2312	5/63A. Connector Socket	IP44	1	12
BC1-4505-2413	5/63A. Panel Mounted Socket	IP44	1	24
BC1-4505-2114	5/63A. Panel Mounted Plug	IP44	1	24
BC1-4505-2420	5/63A. 45° Angled Panel Mounted Socket	IP44	1	24
BC1-4505-2510	5/63A. Surface Mounted Socket	IP44	1	12
BC1-4505-2535	5/63A. 90° Angled Surface Socket	IP44	1	7
BC1-4505-2537	5/63A. 90° Angled Surface Socket with Schuko	IP44	1	7
BC1-4505-2210	5/63A. Surface Mounted Plug	IP44	1	12
BC1-4505-2236	5/63A. 90° Angled Surface Plug	IP44	1	7
BC1-4505-2238	5/63A. 90° Angled Surface Plug with Schuko	IP44	1	7

Product Code	Description	IP	Box	Pack
BC1-4505-7011	5/63A. Straight Plug	IP67	1	12
BC1-4505-7312	5/63A. Connector Socket	IP67	1	12
BC1-4505-7413	5/63A. Panel Mounted Socket	IP67	1	24
BC1-4505-7114	5/63A. Panel Mounted Plug	IP67	1	24
BC1-4505-7420	5/63A. 45° Angled Panel Mounted Socket	IP67	1	24
BC1-4505-7510	5/63A. Surface Mounted Socket	IP67	1	12
BC1-4505-7535	5/63A. 90° Angled Surface Socket	IP67	1	7
BC1-4505-7537	5/63A. 90° Angled Surface Socket with Schuko	IP67	1	7
BC1-4505-7210	5/63A. Surface Mounted Plug	IP67	1	12
BC1-4505-7236	5/63A. 90° Angled Surface Plug	IP67	1	7
BC1-4505-7238	5/63A. 90° Angled Surface Plug with Schuko	IP67	1	7



3/125A. (2P+E)
 220V. 50/60 Hz. 6h
 (Poliamid 6)



Product Code	Description	IP	Box	Pack
BC1-6403-7011	3/125A. Straight Plug	IP67	1	8
BC1-6403-7312	3/125A. Connector Socket	IP67	1	8
BC1-6403-7413	3/125A. Panel Mounted Socket	IP67	1	8
BC1-6403-7114	3/125A. Panel Mounted Plug	IP67	1	8
BC1-6403-7420	3/125A. 45° Angled Panel Mounted Socket	IP67	1	8
BC1-6403-7236	3/125A. 90° Angled Surface Plug	IP67	1	4
BC1-6403-7535	3/125A. 90° Angled Surface Socket	IP67	1	4
BC1-6403-7238	3/125A. 90° Angled Surface Plug with Schuko	IP67	1	4
BC1-6403-7537	3/125A. 90° Angled Surface Socket with Schuko	IP67	1	4
BC1-6403-7240	3/125A. 90° Angled Surface Plug with Pako Switch	IP65	1	4
BC1-6403-7550	3/125A. 90° Angled Surface Socket with Pako Switch	IP65	1	4

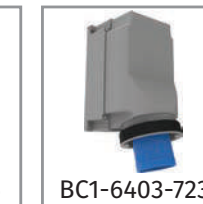

4/125A. (3P+E)
380V. 50/60 Hz. 6h
(Poliamid 6)

	Product Code	Description	IP	Box	Pack
 BC1-6504-7011	BC1-6504-7011	4/125A. Straight Plug	IP67	1	8
 BC1-6504-7312	BC1-6504-7312	4/125A. Connector Socket	IP67	1	8
 BC1-6504-7413	BC1-6504-7413	4/125A. Panel Mounted Socket	IP67	1	8
 BC1-6504-7114	BC1-6504-7114	4/125A. Panel Mounted Plug	IP67	1	8
 BC1-6504-7420	BC1-6504-7420	4/125A. 45° Angled Panel Mounted Socket	IP67	1	8
 BC1-6504-7236	BC1-6504-7236	4/125A. 90° Angled Surface Plug	IP67	1	4
 BC1-6504-7535	BC1-6504-7535	4/125A. 90° Angled Surface Socket	IP67	1	4
 BC1-6504-7238	BC1-6504-7238	4/125A. 90° Angled Surface Plug with Schuko	IP67	1	4
 BC1-6504-7537	BC1-6504-7537	4/125A. 90° Angled Surface Socket with Schuko	IP67	1	4
 BC1-6504-7240	BC1-6504-7240	4/125A. 90° Angled Surface Plug with Pako Switch	IP65	1	4
 BC1-6504-7550	BC1-6504-7550	4/125A. 90° Angled Surface Socket with Pako Switch	IP65	1	4
 BC1-6504-7550	BC1-6504-7550				
 BC1-6504-7240	BC1-6504-7240				
 BC1-6504-7537	BC1-6504-7537				
 BC1-6504-7238	BC1-6504-7238				
 BC1-6504-7535	BC1-6504-7535				
 BC1-6504-7236	BC1-6504-7236				

5/125A. (3P+E+N)
 380V. 50/60 Hz. 6h
 (Poliamid 6)

Product Code	Description	IP	Box	Pack
BC1-6505-7011	5/125A. Straight Plug	IP67	1	8
BC1-6505-7312	5/125A. Connector Socket	IP67	1	8
BC1-6505-7413	5/125A. Panel Mounted Socket	IP67	1	8
BC1-6505-7114	5/125A. Panel Mounted Plug	IP67	1	8
BC1-6505-7420	5/125A. 45° Angled Panel Mounted Socket	IP67	1	8
BC1-6505-7236	5/125A. 90° Angled Surface Plug	IP67	1	4
BC1-6505-7535	5/125A. 90° Angled Surface Socket	IP67	1	4
BC1-6505-7238	5/125A. 90° Angled Surface Plug with Schuko	IP67	1	4
BC1-6505-7537	5/125A. 90° Angled Surface Socket with Schuko	IP67	1	4
BC1-6505-7240	5/125A. 90° Angled Surface Plug with Pako Switch	IP65	1	4
BC1-6505-7550	5/125A. 90° Angled Surface Socket with Pako Switch	IP65	1	4

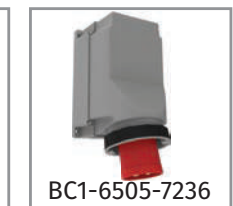
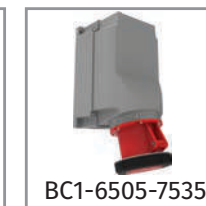







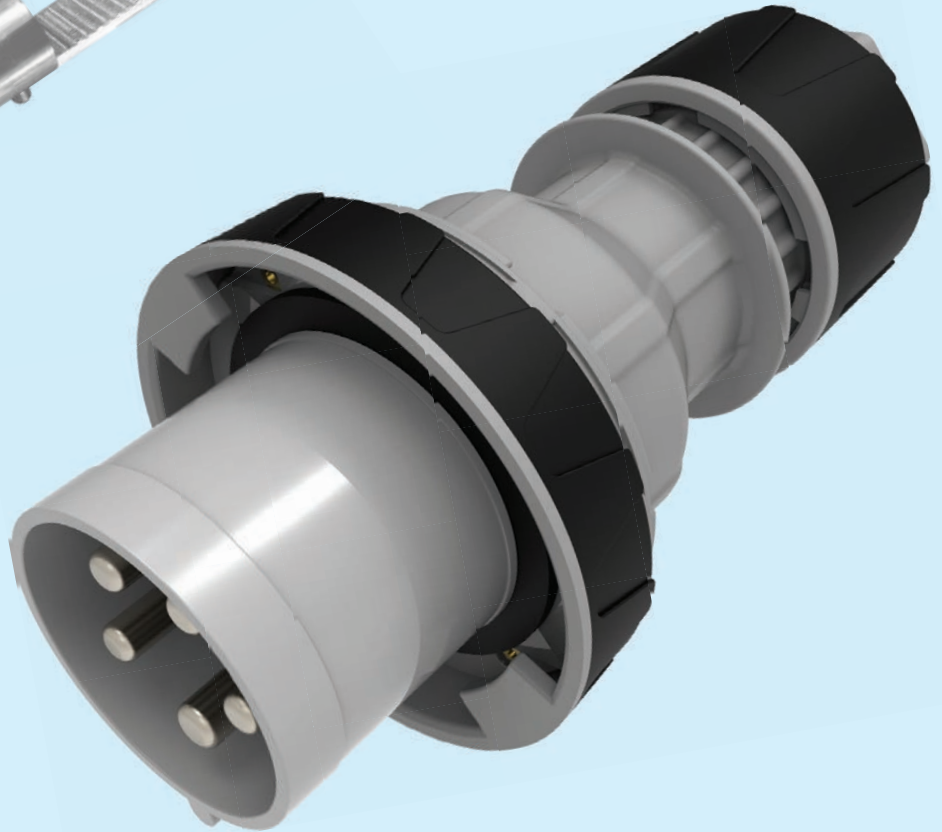



THE FIRST AND ONLY IN TURKEY
CEE Norm 160A. 380V.







Special Silver Plated Contacts



4/160A. (3P+E)
380V. 50/60 Hz. 7h
(Poliamid 6)

	Product Code	Description	IP	Box	Pack
 BC1-8504-7011	BC1-8504-7011	4/160A. Straight Plug	IP67	1	8
 BC1-8504-7312	BC1-8504-7312	4/160A. Connector Socket	IP67	1	8
 BC1-8504-7413	BC1-8504-7413	4/160A. Panel Mounted Socket	IP67	1	8
 BC1-8504-7114	BC1-8504-7114	4/160A. Panel Mounted Plug	IP67	1	8
 BC1-8504-7420	BC1-8504-7420	4/160A. 45° Angled Panel Mounted Socket	IP67	1	8
 BC1-8504-7236	BC1-8504-7236	4/160A. 90° Angled Surface Plug	IP67	1	4
 BC1-8504-7535	BC1-8504-7535	4/160A. 90° Angled Surface Socket	IP67	1	4
 BC1-8504-7238	BC1-8504-7238	4/160A. 90° Angled Surface Plug with Schuko	IP67	1	4
 BC1-8504-7537	BC1-8504-7537	4/160A. 90° Angled Surface Socket with Schuko	IP67	1	4
 BC1-8504-7240	BC1-8504-7240	4/160A. 90° Angled Surface Plug with Pako Switch	IP65	1	4
 BC1-8504-7550	BC1-8504-7550	4/160A. 90° Angled Surface Socket with Pako Switch	IP65	1	4

5/160A. (3P+E+N)
380V. 50/60 Hz. 7h
(Poliamid 6)

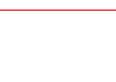
	Product Code	Description	IP	Box	Pack
 BC1-8505-7011	BC1-8505-7011	5/160A. Straight Plug	IP67	1	8
 BC1-8505-7312	BC1-8505-7312	5/160A. Connector Socket	IP67	1	8
 BC1-8505-7413	BC1-8505-7413	5/160A. Panel Mounted Socket	IP67	1	8
 BC1-8505-7114	BC1-8505-7114	5/160A. Panel Mounted Plug	IP67	1	8
 BC1-8505-7420	BC1-8505-7420	5/160A. 45° Angled Panel Mounted Socket	IP67	1	8
 BC1-8505-7236	BC1-8505-7236	5/160A. 90° Angled Surface Plug	IP67	1	4
 BC1-8505-7535	BC1-8505-7535	5/160A. 90° Angled Surface Socket	IP67	1	4
 BC1-8505-7238	BC1-8505-7238	5/160A. 90° Angled Surface Plug with Schuko	IP67	1	4
 BC1-8505-7537	BC1-8505-7537	5/160A. 90° Angled Surface Socket with Schuko	IP67	1	4
 BC1-8505-7240	BC1-8505-7240	5/160A. 90° Angled Surface Plug with Pako Switch	IP65	1	4
 BC1-8505-7550	BC1-8505-7550	5/160A. 90° Angled Surface Socket with Pako Switch	IP65	1	4

5 YEARS WARRANTY

IP44



IP67



3/16A. (2P+E) 220V. 50/60 Hz. 6h (Poliamid 6)

Product Code	Description	IP	Box	Pack
BCS-1403-2011	3/16A. Straight Plug	IP44	10	180
BCS-1403-2312	3/16A. Connector Socket	IP44	10	180
BCS-1403-2413	3/16A. Panel Mounted Socket	IP44	15	180
BCS-1403-2114	3/16A. Panel Mounted Plug	IP44	10	180
BCS-1403-2420	3/16A. 45° Angled Panel Mounted Socket	IP44	8	144

Product Code	Description	IP	Box	Pack
BCS-1403-7011	3/16A. Straight Plug	IP67	8	144
BCS-1403-7312	3/16A. Connector Socket	IP67	8	144
BCS-1403-7413	3/16A. Panel Mounted Socket	IP67	8	144
BCS-1403-7114	3/16A. Panel Mounted Plug	IP67	10	180
BCS-1403-7420	3/16A. 45° Angled Panel Mounted Socket	IP67	6	108

4/16A. (3P+E) 380V. 50/60 Hz. 6h (Poliamid 6)

IP44



IP67



Product Code	Description	IP	Box	Pack
BCS-1504-2011	4/16A. Straight Plug	IP44	8	144
BCS-1504-2312	4/16A. Connector Socket	IP44	8	144
BCS-1504-2413	4/16A. Panel Mounted Socket	IP44	15	180
BCS-1504-2114	4/16A. Panel Mounted Plug	IP44	10	180
BCS-1504-2420	4/16A. 45° Angled Panel Mounted Socket	IP44	8	144

Product Code	Description	IP	Box	Pack
BCS-1504-7011	4/16A. Straight Plug	IP67	6	108
BCS-1504-7312	4/16A. Connector Socket	IP67	6	108
BCS-1504-7413	4/16A. Panel Mounted Socket	IP67	6	108
BCS-1504-7114	4/16A. Panel Mounted Plug	IP67	10	180
BCS-1504-7420	4/16A. 45° Angled Panel Mounted Socket	IP67	6	108

5/16A. (3P+E+N) 380V. 50/60 Hz. 6h (Poliamid 6)

IP44



IP67



Product Code	Description	IP	Box	Pack
BCS-1505-2011	5/16A. Straight Plug	IP44	8	144
BCS-1505-2312	5/16A. Connector Socket	IP44	8	144
BCS-1505-2413	5/16A. Panel Mounted Socket	IP44	15	180
BCS-1505-2114	5/16A. Panel Mounted Plug	IP44	8	144
BCS-1505-2420	5/16A. 45° Angled Panel Mounted Socket	IP44	6	108

Product Code	Description	IP	Box	Pack
BCS-1505-7011	5/16A. Straight Plug	IP67	4	72
BCS-1505-7312	5/16A. Connector Socket	IP67	4	72
BCS-1505-7413	5/16A. Panel Mounted Socket	IP67	6	108
BCS-1505-7114	5/16A. Panel Mounted Plug	IP67	6	108
BCS-1505-7420	5/16A. 45° Angled Panel Mounted Socket	IP67	6	108

3/32A. (2P+E) 220V. 50/60 Hz. 6h (Poliamid 6)

Product Code	Description	IP	Box	Pack
BCS-3403-2011	3/32A. Straight Plug	IP44	8	96
BCS-3403-2312	3/32A. Connector Socket	IP44	8	96
BCS-3403-2413	3/32A. Panel Mounted Socket	IP44	8	96
BCS-3403-2114	3/32A. Panel Mounted Plug	IP44	8	144
BCS-3403-2420	3/32A. 45° Angled Panel Mounted Socket	IP44	4	72

IP44

Product Code	Description	IP	Box	Pack
BCS-3403-7011	3/32A. Straight Plug	IP67	3	54
BCS-3403-7312	3/32A. Connector Socket	IP67	3	54
BCS-3403-7413	3/32A. Panel Mounted Socket	IP67	4	72
BCS-3403-7114	3/32A. Panel Mounted Plug	IP67	6	108
BCS-3403-7420	3/32A. 45° Angled Panel Mounted Socket	IP67	4	72

IP67

4/32A. (3P+E) 380V. 50/60 Hz. 6h (Poliamid 6)

Product Code	Description	IP	Box	Pack
BCS-3504-2011	4/32A. Straight Plug	IP44	8	96
BCS-3504-2312	4/32A. Connector Socket	IP44	8	96
BCS-3504-2413	4/32A. Panel Mounted Socket	IP44	8	96
BCS-3504-2114	4/32A. Panel Mounted Plug	IP44	8	144
BCS-3504-2420	4/32A. 45° Angled Panel Mounted Socket	IP44	4	72

IP44

Product Code	Description	IP	Box	Pack
BCS-3504-7011	4/32A. Straight Plug	IP67	3	54
BCS-3504-7312	4/32A. Connector Socket	IP67	3	54
BCS-3504-7413	4/32A. Panel Mounted Socket	IP67	4	72
BCS-3504-7114	4/32A. Panel Mounted Plug	IP67	6	108
BCS-3504-7420	4/32A. 45° Angled Panel Mounted Socket	IP67	4	72

IP67

5/32A. (3P+E+N) 380V. 50/60 Hz. 6h (Poliamid 6)

Product Code	Description	IP	Box	Pack
BCS-3505-2011	5/32A. Straight Plug	IP44	8	96
BCS-3505-2312	5/32A. Connector Socket	IP44	8	96
BCS-3505-2413	5/32A. Panel Mounted Socket	IP44	8	96
BCS-3505-2114	5/32A. Panel Mounted Plug	IP44	8	144
BCS-3505-2420	5/32A. 45° Angled Panel Mounted Socket	IP44	6	108

IP44

Product Code	Description	IP	Box	Pack
BCS-3505-7011	5/32A. Straight Plug	IP67	3	54
BCS-3505-7312	5/32A. Connector Socket	IP67	3	54
BCS-3505-7413	5/32A. Panel Mounted Socket	IP67	4	72
BCS-3505-7114	5/32A. Panel Mounted Plug	IP67	6	108
BCS-3505-7420	5/32A. 45° Angled Panel Mounted Socket	IP67	4	72

IP67



3/63A. (2P+E) 220V. 50/60 Hz. 6h (Poliamid 6)



Product Code	Description	IP	Box	Pack
BCS-4403-2011	3/63A. Straight Plug	IP44	1	12
BCS-4403-2312	3/63A. Connector Socket	IP44	1	12
BCS-4403-2413	3/63A. Panel Mounted Socket	IP44	1	24
BCS-4403-2114	3/63A. Panel Mounted Plug	IP44	1	24
BCS-4403-2420	3/63A. 45° Angled Panel Mounted Socket	IP44	1	24



Product Code	Description	IP	Box	Pack
BCS-4403-7011	3/63A. Straight Plug	IP67	1	12
BCS-4403-7312	3/63A. Connector Socket	IP67	1	12
BCS-4403-7413	3/63A. Panel Mounted Socket	IP67	1	24
BCS-4403-7114	3/63A. Panel Mounted Plug	IP67	1	24
BCS-4403-7420	3/63A. 45° Angled Panel Mounted Socket	IP67	1	24

4/63A. (3P+E) 380V. 50/60 Hz. 6h (Poliamid 6)



Product Code	Description	IP	Box	Pack
BCS-4504-2011	4/63A. Straight Plug	IP44	1	12
BCS-4504-2312	4/63A. Connector Socket	IP44	1	12
BCS-4504-2413	4/63A. Panel Mounted Socket	IP44	1	24
BCS-4504-2114	4/63A. Panel Mounted Plug	IP44	1	24
BCS-4504-2420	4/63A. 45° Angled Panel Mounted Socket	IP44	1	24



Product Code	Description	IP	Box	Pack
BCS-4504-7011	4/63A. Straight Plug	IP67	1	12
BCS-4504-7312	4/63A. Connector Socket	IP67	1	12
BCS-4504-7413	4/63A. Panel Mounted Socket	IP67	1	24
BCS-4504-7114	4/63A. Panel Mounted Plug	IP67	1	24
BCS-4504-7420	4/63A. 45° Angled Panel Mounted Socket	IP67	1	24

5/63A. (3P+E+N) 380V. 50/60 Hz. 6h (Poliamid 6)



Product Code	Description	IP	Box	Pack
BCS-4505-2011	5/63A. Straight Plug	IP44	1	12
BCS-4505-2312	5/63A. Connector Socket	IP44	1	12
BCS-4505-2413	5/63A. Panel Mounted Socket	IP44	1	24
BCS-4505-2114	5/63A. Panel Mounted Plug	IP44	1	24
BCS-4505-2420	5/63A. 45° Angled Panel Mounted Socket	IP44	1	24



Product Code	Description	IP	Box	Pack
BCS-4505-7011	5/63A. Straight Plug	IP67	1	12
BCS-4505-7312	5/63A. Connector Socket	IP67	1	12
BCS-4505-7413	5/63A. Panel Mounted Socket	IP67	1	24
BCS-4505-7114	5/63A. Panel Mounted Plug	IP67	1	24
BCS-4505-7420	5/63A. 45° Angled Panel Mounted Socket	IP67	1	24



3/125A. (2P+E) 220V. 50/60 Hz. 6h (Poliamid 6)

Product Code	Description	IP	Box	Pack
BCS-6403-7011	3/125A. Straight Plug	IP67	1	8
BCS-6403-7312	3/125A. Connector Socket	IP67	1	8
BCS-6403-7413	3/125A. Panel Mounted Socket	IP67	1	8
BCS-6403-7114	3/125A. Panel Mounted Plug	IP67	1	8
BCS-6403-7420	3/125A. 45° Angled Panel Mounted Socket	IP67	1	8

IP67

BCS-6403-7413

BCS-6403-7114

BCS-6403-7420

4/125A. (3P+E) 380V. 50/60 Hz. 6h (Poliamid 6)

Product Code	Description	IP	Box	Pack
BCS-6504-7011	4/125A. Straight Plug	IP67	1	8
BCS-6504-7312	4/125A. Connector Socket	IP67	1	8
BCS-6504-7413	4/125A. Panel Mounted Socket	IP67	1	8
BCS-6504-7114	4/125A. Panel Mounted Plug	IP67	1	8
BCS-6504-7420	4/125A. 45° Angled Panel Mounted Socket	IP67	1	8

IP67

BCS-6504-7413

BCS-6504-7114

BCS-6504-7420

5/125A. (3P+E+N) 380V. 50/60 Hz. 6h (Poliamid 6)

Product Code	Description	IP	Box	Pack
BCS-6505-7011	5/125A. Straight Plug	IP67	1	8
BCS-6505-7312	5/125A. Connector Socket	IP67	1	8
BCS-6505-7413	5/125A. Panel Mounted Socket	IP67	1	8
BCS-6505-7114	5/125A. Panel Mounted Plug	IP67	1	8
BCS-6505-7420	5/125A. 45° Angled Panel Mounted Socket	IP67	1	8

IP67



BCS-6505-7413

BCS-6505-7114

BCS-6505-7420

Inverter Connector®

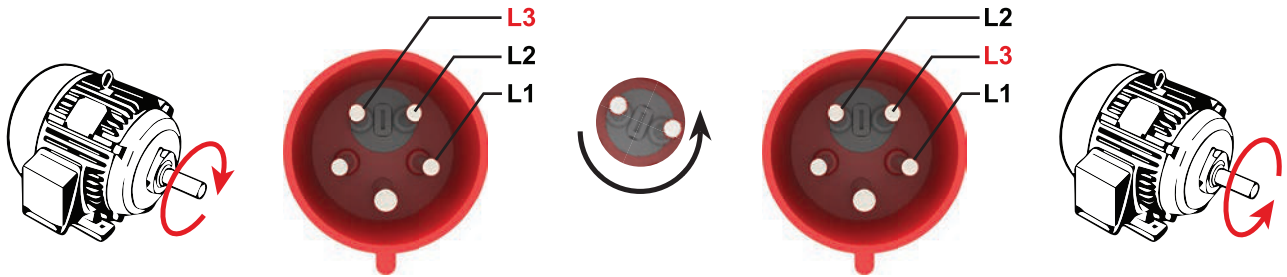
Inverter Plug



Changing phase, only 5 seconds on 3 phase motors inversion problem happen for mobile machines, solve this problem with screwdriver only 5 seconds

5/16A. BC1-1505-2050
5/32A. BC1-3505-2050



IP44

5/16A. BC1-1505-2080
5/32A. BC1-3505-2080



IP44

5/16A. BC1-1505-2070
5/32A. BC1-3505-2070



IP44

5/16A. BC1-1505-2060
5/32A. BC1-3505-2060



IP44

5/16A. BC1-1505-7050
5/32A. BC1-3505-7050



IP67

5/16A. BC1-1505-7070
5/32A. BC1-3505-7070



IP67

5/16A. BC1-1505-7060
5/32A. BC1-3505-7060



IP67

5/16A. BC1-1505-2061
5/32A. BC1-3505-2061



IP44



**5 YEARS
WARRANTY**

24 Volt

24 Volt
CEE Norm Plug and Socket Series

**2/16A. - 3/16A. - 2/32A. - 3/32A.
IP44 - IP67**





Product Code	Description	IP	Box	Pack
BG4-100X-0X0X	Group Socket Box (Imperforate)	IP44	1	24
BG4-100Y-0Y0Y	Group Socket Box (Big Hole)	IP44	1	24
BG4-1010-1010	1/16A. 220V. 3 Pcs.	IP44	1	12
BG4-1014-1414	3/16A. 220V. 3 Pcs.	IP44	1	12
BG4-1016-1010	5/16A. 380V. 1 Pc. + 1/16A. 220V. 2 Pcs.	IP44	1	12
BG4-1016-1610	5/16A. 380V. 2 Pcs. + 1/16A. 220V. 1 Pc.	IP44	1	12
BG4-1016-1614	5/16A. 380V. 2 Pcs. + 3/16A. 220V. 1 Pc.	IP44	1	12
BG4-1016-1616	5/16A. 380V. 3 Pcs.	IP44	1	12
BG4-1017-1717	3/32A. 220V. 3 Pcs.	IP44	1	12
BG4-1018-1818	4/32A. 380V. 3 Pcs.	IP44	1	12
BG4-1019-1010	5/32A. 380V. 1 Pc. + 1/16A. 220V. 2 Pcs.	IP44	1	12
BG4-1019-1514	5/32A. 380V. 1 Pc. + 4/16A. 380V. 1 Pc. + 3/16A. 220V. 1 Pc.	IP44	1	12
BG4-1019-1614	5/32A. 380V. 1 Pc. + 5/16A. 380V. 1 Pc. + 3/16A. 220V. 1 Pc.	IP44	1	12
BG4-1019-1910	5/32A. 380V. 2 Pcs. + 1/16A. 220V. 1 Pc.	IP44	1	12
BG4-1019-1914	5/32A. 380V. 2 Pcs. + 3/16A. 220V. 1 Pc.	IP44	1	12
BG4-1019-1916	5/32A. 380V. 2 Pcs. + 5/16A. 380V. 1 Pc.	IP44	1	12
BG4-1019-1917	5/32A. 380V. 2 Pcs. + 3/32A. 220V. 1 Pc.	IP44	1	12
BG4-1019-1919	5/32A. 380V. 3 Pcs.	IP44	1	12
BG4-101K-1K1K	2/16A. 24V. 3 Pcs.	IP44	1	12
BG4-101L-1K1K	3/16A. 24V. 1 Pc. + 2/16A. 24V. 2 Pcs.	IP44	1	12
BG4-101L-1L1L	3/16A. 24V. 3 Pcs.	IP44	1	12
BG4-101M-1K1K	2/32A. 24V. 1 Pc. + 2/16A. 24V. 2 Pcs.	IP44	1	12
BG4-101M-1M1M	2/32A. 24V. 3 Pcs.	IP44	1	12
BG4-101N-1L1L	3/32A. 24V. 1 Pc. + 3/16A. 24V. 2 Pcs.	IP44	1	12
BG4-101N-1M1M	3/32A. 24V. 1 Pc. + 2/32A. 24V. 2 Pcs.	IP44	1	12
BG4-101N-1N1N	3/32A. 24V. 3 Pcs.	IP44	1	12
BG4-111Y-1Y1Y	Group Socket Box Yellow (Big Hole)	IP44	1	24
BG4-101T-1T1T	1/16A. 220V. 3 Pcs. Thermal Fuse	IP44	1	12

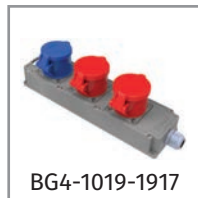

Note: Our yellow colour group socket box product is produced to order with a minimum of 100 pcs.

Product Code	Description	IP	Box	Pack
BG6-100X-0X0X	Group Socket Box (Imperforate)	IP67	1	24
BG6-1010-1010	3/16A. 220V. 3 Pcs.	IP67	1	12
BG6-1014-1414	5/16A. 380V. 1 Pc. + 1/16A. 220V. 2 Pcs.	IP67	1	12
BG6-1016-1010	5/16A. 380V. 1 Pc. + 3/16A. 220V. 1 Pc. + 1/16A. 220V. 1 Pc.	IP67	1	12
BG6-1016-1410	5/16A. 380V. 2 Pcs. + 1/16A. 220V. 1 Pc.	IP67	1	12
BG6-1016-1610	5/16A. 380V. 2 Pcs. + 3/16A. 220V. 1 Pc.	IP67	1	12
BG6-1016-1614	5/16A. 380V. 3 Pcs.	IP67	1	12
BG6-1016-1616	3/32A. 220V. 3 Pcs.	IP67	1	12
BG6-1017-1717	4/32A. 380V. 3 Pcs.	IP67	1	12
BG6-1018-1818	5/32A. 380V. 1 Pc. + 1/16A. 220V. 2 Pcs.	IP67	1	12
BG6-1019-1010	5/32A. 380V. 2 Pcs. + 1/16A. 220V. 1 Pc.	IP67	1	12
BG6-1019-1910	5/32A. 380V. 2 Pcs. + 3/16A. 220V. 1 Pc.	IP67	1	12
BG6-1019-1914	5/32A. 380V. 2 Pcs. + 5/16A. 380V. 1 Pc.	IP67	1	12
BG6-1019-1916	5/32A. 380V. 2 Pcs. + 3/32A. 220V. 1 Pc.	IP67	1	12
BG6-1019-1917	5/32A. 380V. 3 Pcs.	IP67	1	12
BG6-1019-1919	2/16A. 24V. 3 Pcs.	IP67	1	12
BG6-101K-1K1K	3/16A. 24V. 1 Pc. + 2/16A. 24V. 2 Pcs.	IP67	1	12
BG6-101L-1K1K	3/16A. 24V. 3 Pcs.	IP67	1	12
BG6-101L-1L1L	2/32A. 24V. 1 Pc. + 2/16A. 24V. 2 Pcs.	IP67	1	12
BG6-101M-1K1K	2/32A. 24V. 3 Pcs.	IP67	1	12
BG6-101M-1M1M	3/32A. 24V. 1 Pc. + 3/16A. 24V. 2 Pcs.	IP67	1	12
BG6-101N-1L1L	3/32A. 24V. 1 Pc. + 2/32A. 24V. 2 Pcs.	IP67	1	12
BG6-101N-1M1M	3/32A. 24V. 3 Pcs.	IP67	1	12
BG6-101N-1N1N	1/16A. 220V. 3 Pcs.	IP67	1	12



Our IP67 Tribox products are suitable for 75X75 cm frame

Product Code	Description	IP	Box	Pack
BX1-0000-0000	CEE Norm Unplugged Box	IP44	1	6
BX1-0111-0000	CEE Norm 1/16A. 3 Pcs. Box	IP44	1	6
BX1-0TTT-0000	CEE Norm 1/16A. 3 Pcs. Themal Fuseli Box	IP44	1	6
BX1-0222-0000	CEE Norm 3/16A. 3 Pcs. Box	IP44	1	6
BX1-0333-0000	CEE Norm 4/16A. 3 Pcs. Box	IP44	1	6
BX1-0333-2100	CEE Norm 4/16A. 3 Pcs. + 1/16A. 2 Pcs. Box	IP44	1	6
BX1-0441-0000	CEE Norm 5/16A. 2 Pcs. + 1/16A. 1 Pcs. Box	IP44	1	6
BX1-0444-0000	CEE Norm 5/16A. 3 Pcs. Box	IP44	1	6
BX1-0444-2100	CEE Norm 5/16A. 3 Pcs. + 1/16A. 2 Pcs. Box	IP44	1	6
BX1-0442-2100	CEE Norm 5/16A. 2 Pcs. + 3/16A. 1 Pcs. + 1/16A. 2 Pcs. Box	IP44	1	6
BX1-0555-0000	CEE Norm 3/32A. 3 Pcs. Box	IP44	1	6
BX1-0666-0000	CEE Norm 4/32A. 3 Pcs. Box	IP44	1	6
BX1-0666-2100	CEE Norm 4/32A. 3 Pcs. + 1/16A. 2 Pcs. Box	IP44	1	6
BX1-0771-0000	CEE Norm 5/32A. 2 Pcs. + 1/16A. 1 Pcs. Box	IP44	1	6
BX1-0777-0000	CEE Norm 5/32A. 3 Pcs. Box	IP44	1	6
BX1-0777-2100	CEE Norm 5/32A. 3 Pcs. + 1/16A. 2 Pcs. Box	IP44	1	6
BX1-0KKK-0000	CEE Norm 2/16A. 24V. 3 Pcs. Box	IP44	1	6
BX1-0LLL-0000	CEE Norm 3/16A. 24V. 3 Pcs. Box	IP44	1	6
BX1-0MMM-0000	CEE Norm 2/32A. 24V. 3 Pcs. Box	IP44	1	6
BX1-0NNN-0000	CEE Norm 3/32A. 24V. 3 Pcs. Box	IP44	1	6

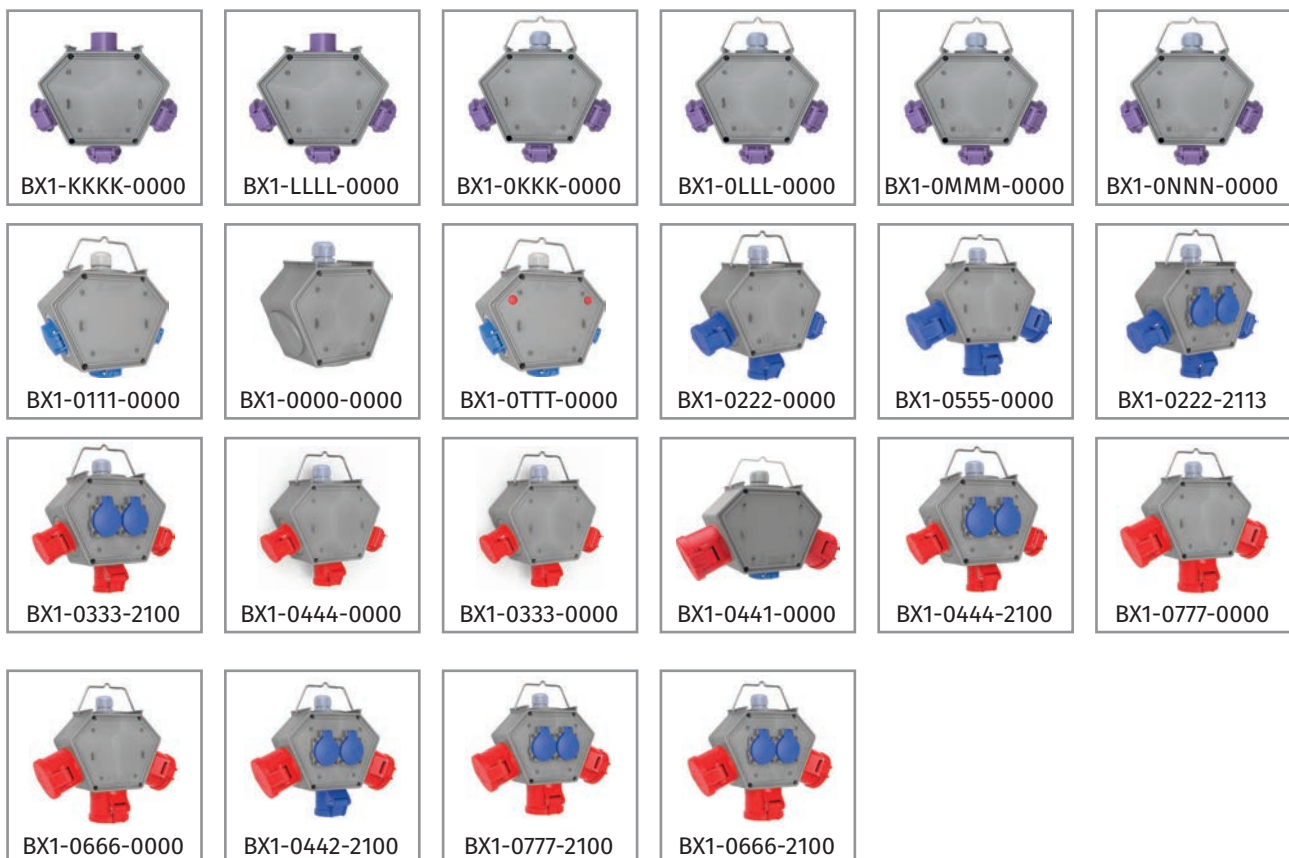

PLUG POLYBOX

Product Code	Description	IP	Box	Pack
BX1-1222-0000	CEE Norm 3/16A. 3 Pcs. + 3/32A. Plug Box	IP44	1	6
BX1-1222-2100	CEE Norm 3/16A. 3 Pcs. + 1/16A. 2 Pcs. + 3/32A. Plug Box	IP44	1	6
BX1-3444-0000	CEE Norm 5/16A. 3 Pcs. + 5/32A. Plug Box	IP44	1	6
BX1-7444-0000	CEE Norm 5/16A. 3 Pcs. + 5/16A. Plug Box	IP44	1	6
BX1-KKKK-0000	CEE Norm 2/16A. 24V. 3 Pcs. + 2/16A. 24V. Plug Box	IP44	1	6
BX1-LLLL-0000	CEE Norm 3/16A. 24V. 3 Pcs. + 3/16A. 24V. Plug Box	IP44	1	6



CABLE POLYBOX

Product Code	Description	IP	Box	Pack
BX1K0333-2100	CEE Norm 4/16A. 3 Pcs. + 1/16A. 2 Pcs. 1,5m Cable Box	IP44	1	6
BX1K0444-2100	CEE Norm 5/16A. 3 Pcs. + 1/16A. 2 Pcs. + 1,5m Cable Box	IP44	1	6
BX1K3444-4000	CEE Norm 5/16A. 4 Pcs. + 5/32A. 1 Pcs. Plug + 1,5m Cable	IP44	1	6
BX1K0777-0000	CEE Norm 5/32A. 3 Pcs. + 1,5m Cable Box	IP44	1	6
BX1K0550-2113	CEE Norm 3/32A. 2 Pcs. + 1/16A. 2 Pcs. + 1,5m Cab. 3 Air Outlet Box	IP44	1	6
BX1K0660-2113	CEE Norm 4/32A. 2 Pcs. + 1/16A. 2 Pcs. + 1,5m Cab. 3 Air Outlet Box	IP44	1	6
BX1K0770-0013	CEE Norm 5/32A. 2 Pcs. + 1,5m Cable, 3 Air Outlet Box	IP44	1	6



AIR OUTLET POLYBOX

Product Code	Description	IP	Box	Pack
BX1-0110-2113	CEE Norm 1/16A. 4 Pcs. + 3 Air Outlet Box	IP44	1	6
BX1-0220-2113	CEE Norm 3/16A. 2 Pcs. + 1/16A. 2Pcs. 3 Air Outlet Box	IP44	1	6
BX1-0222-2113	CEE Norm 3/16A. 3 Pcs. + 1/16A. 2 Pcs. + 3 Air Outlet Box	IP44	1	6
BX1-0330-2113	CEE Norm 4/16A. 2 Pcs. + 1/16A. 2 Pcs. 3 Air Outlet Box	IP44	1	6
BX1-0440-2113	CEE Norm 5/16A. 2 Pcs. + 1/16A. 2 Pcs. + 3 Air Outlet Box	IP44	1	6
BX1-0550-2113	CEE Norm 3/32A. 2 Pcs. + 1/16A. 2 Pcs. + 3 Air Outlet Box	IP44	1	6
BX1-0660-2113	CEE Norm 4/32A. 2 Pcs. + 1/16A. 2 Pcs. + 3 Air Outlet Box	IP44	1	6



120x255x80mm

 Thermal Fuse
 PG16 / PG21 Rakor
 ABS
 IP44
 1

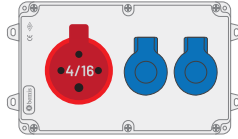

BKP-7215-2000



BKP-7219-1002

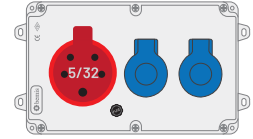

BKP-7219-2009



BKP-7216-1001

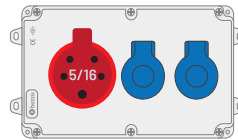

BKP-7216-2000



BKP-7218-1002

210x300x90mm

 Thermal Fuse
 PG16 / PG21 Rakor
 ABS
 IP44
 1

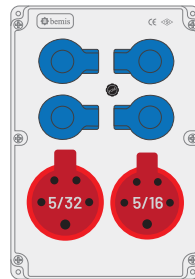

BKP-8296-4009

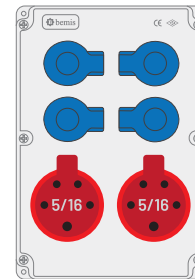

BKP-8226-4000

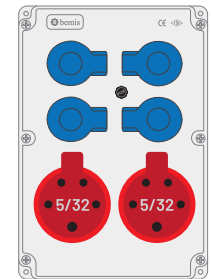

BKP-8229-4009

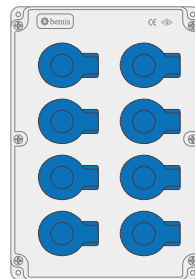

BKP-8280-0000

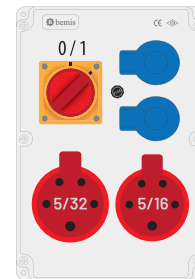

BKP-8296-2002

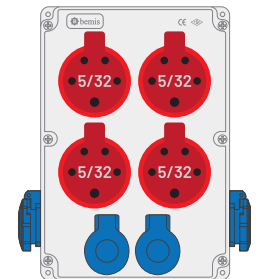

BKP-8249-4000

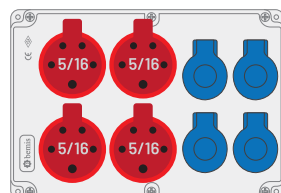

BKP-8246-4000

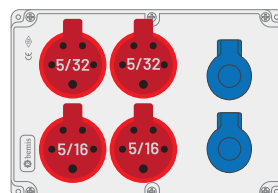

BKP-8229-2620

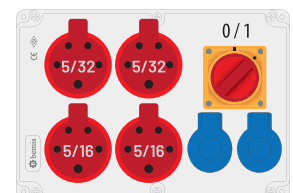

BKP-8229-2621



Thermal Fuse



PG16 / PG21 Rakor



ABS



IP44



1

Handled Powerbox 120x255x80mm

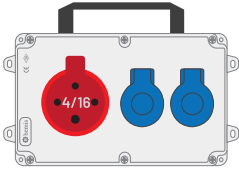

BKP-7215-2007

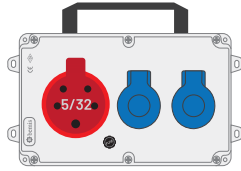

BKP-7219-2003

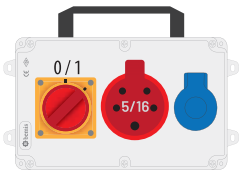

BKP-7216-1008

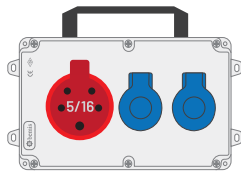

BKP-7216-2007

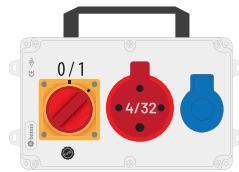

BKP-7218-1004



Thermal Fuse



PG16 / PG21 Rakor



ABS



IP44



1

Handled Powerbox 210x300x90mm

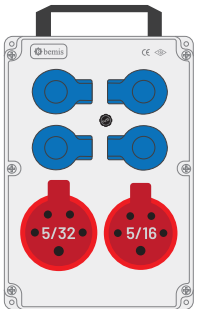

BKP-8219-1643

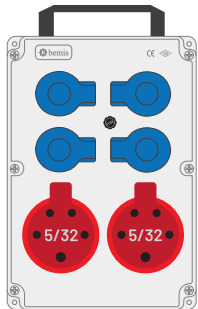

BKP-8229-4003

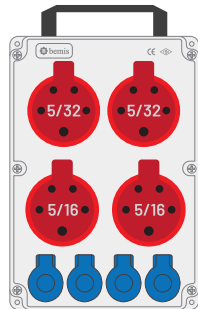

BKP-8229-2647

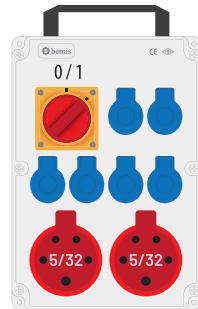

BKP-8229-6008

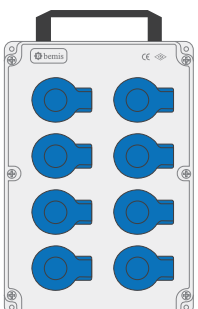

BKP-8280-0007

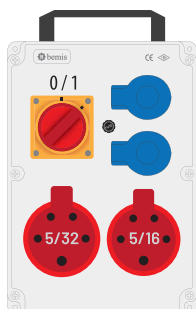

BKP-8296-2004

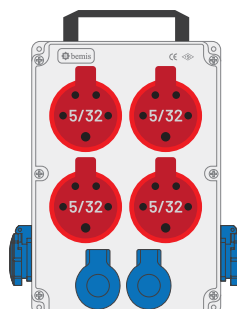

BKP-8249-4007

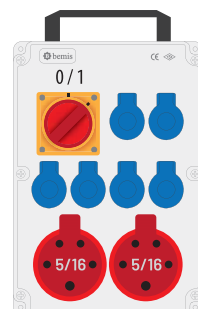

BKP-8226-6008

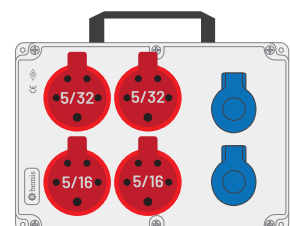

BKP-8229-2697

Handled Cabled Powerbox 120x255x80mm

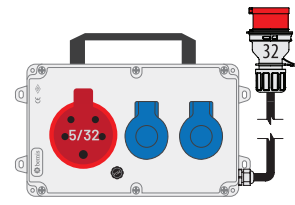
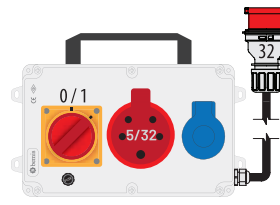
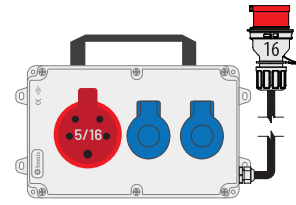
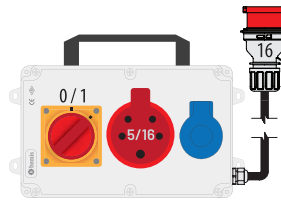
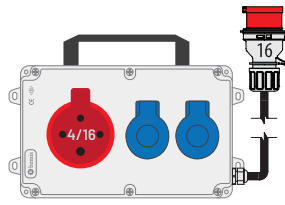
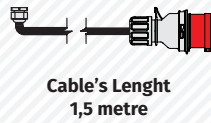

Handled Cabled Powerbox 210x300x90mm

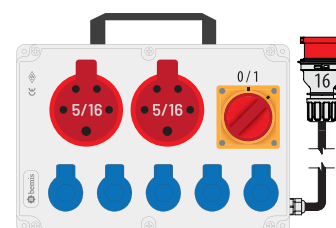
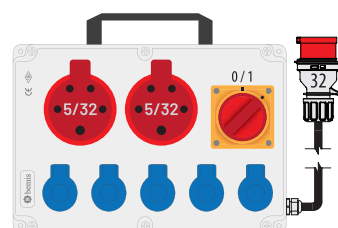
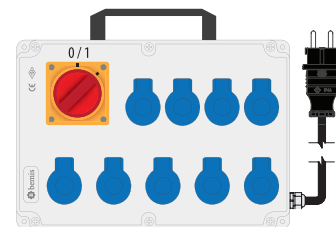
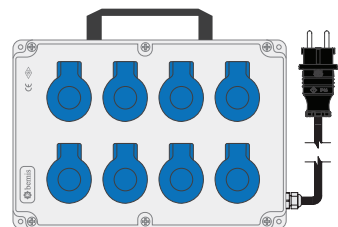
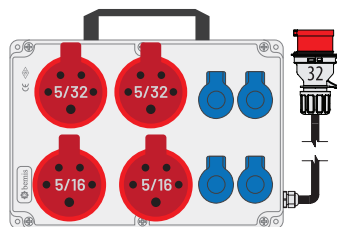
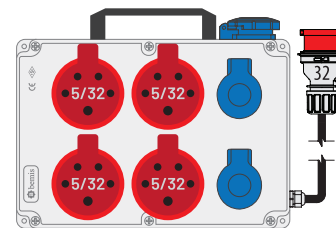
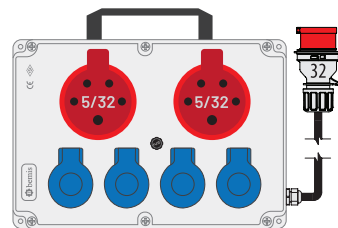
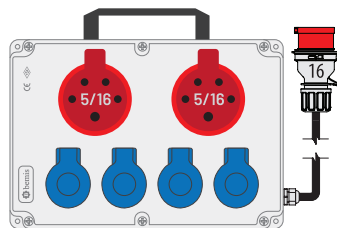
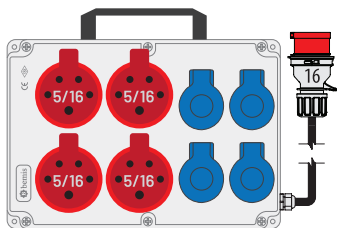
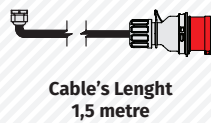



Thermal Fuse



PG16 / PG21 Rakor

ABS

IP44



1

Metal Support Handled Powerbox 210x300x90mm

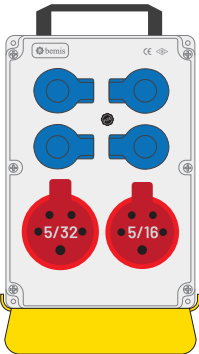

BKP-8296-4025

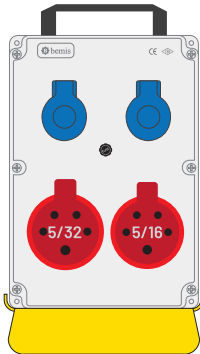

BKP-8296-2025

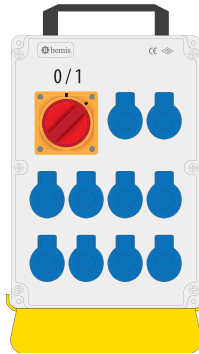

BKP-8250-5022

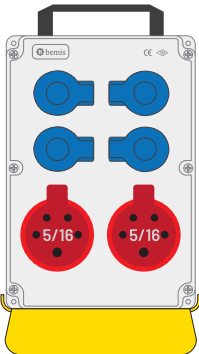

BKP-8226-4021

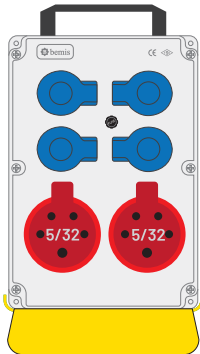

BKP-8229-4025

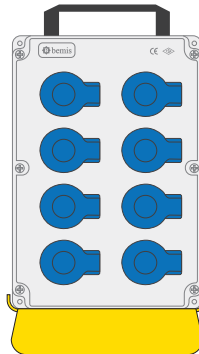

BKP-8280-0021

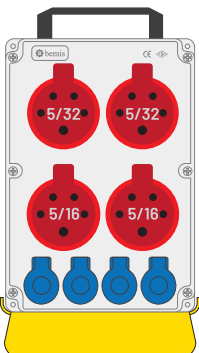

BKP-8229-26421

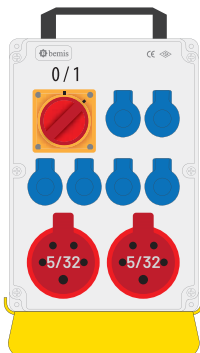

BKP-8229-6024

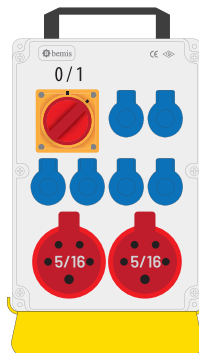

BKP-8226-6024

Powerbox with metal Stand
210x300x90mm



Thermal Fuse



PG16 / PG21
Rakor



ABS



IP44



1

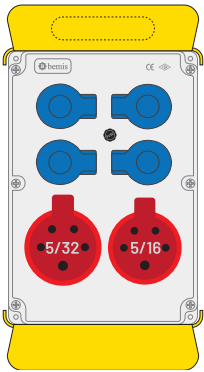

BKP-8296-4020

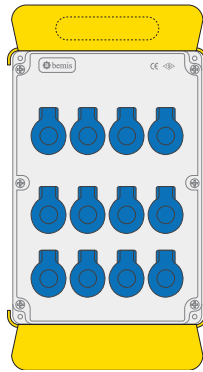

BKP-8260-6016

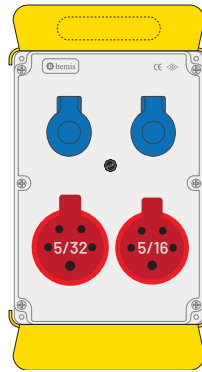

BKP-8296-2020

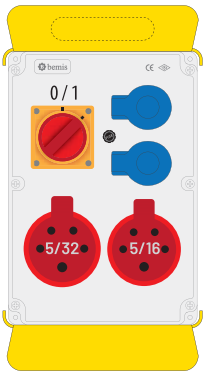

BKP-8296-2017

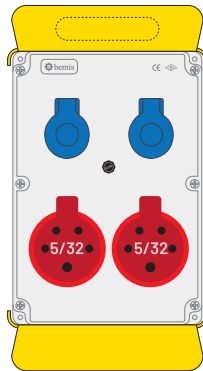

BKP-8229-2020

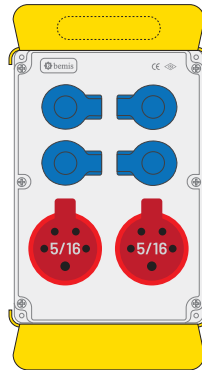

BKP-8226-4016

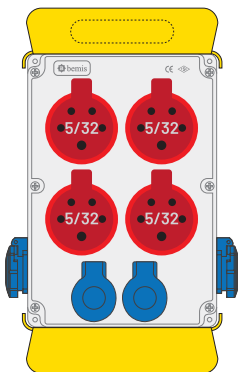

BKP-8249-4016



Powerbox With Corrugated Bar 210x300x90mm

Cable's Lenght 1,5 metre



Thermal Fuse



PG16 / PG21 Rakor



ABS



IP44



1

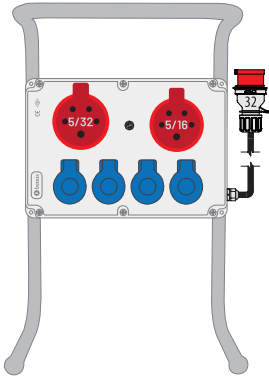

BKP38296-4011

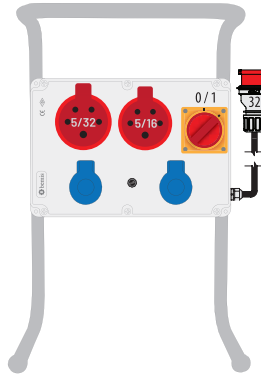

BKP38296-2013

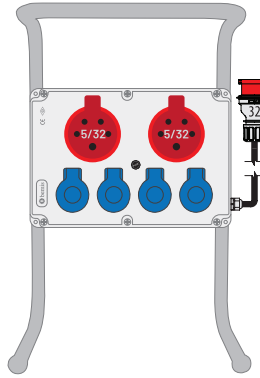

BKP38229-4011

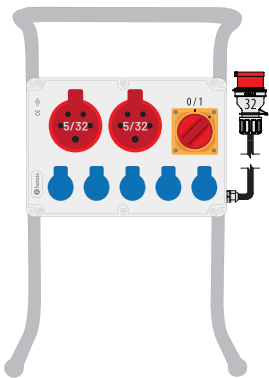

BKP38229-5015

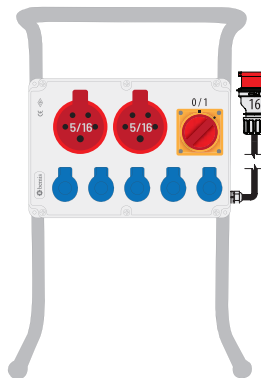

BKP78226-5015

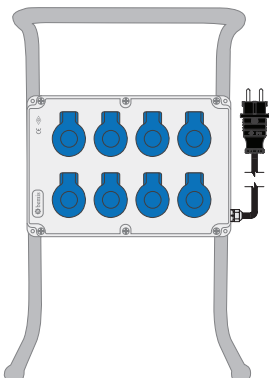

BKP98280-0012

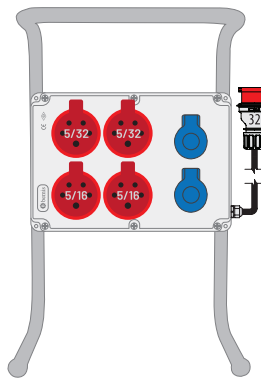

BKP38229-26212

**CEE Norm
Interlock Socket
380V. 3P+E+N (ABS)**

Product Code	Description	IP	Box	Pack
BC1-1403-7540	3/16A. 90° Angled Surface Socket	IP67	1	0
BC1-1403-7560	3/16A. Surface Mounted Socket	IP67	1	0
BC1-1504-7540	4/16A. 90° Angled Surface Socket	IP67	1	0
BC1-1504-7560	4/16A. Surface Mounted Socket	IP67	1	0
BC1-1505-7540	5/16A. 90° Angled Surface Socket	IP67	1	0
BC1-1505-7560	5/16A. Surface Mounted Socket	IP67	1	0
BC1-3403-7540	3/32A. 90° Angled Surface Socket	IP67	1	0
BC1-3504-7540	4/32A. 90° Angled Surface Socket	IP67	1	0
BC1-3505-7540	5/32A. 90° Angled Surface Socket	IP67	1	0
BC1-4504-7540	4/63A. 90° Angled Surface Socket	IP67	1	0
BC1-4505-7540	5/63A. 90° Angled Surface Socket	IP67	1	0



Product Code	Description	IP	Box	Pack
BA1-1001-0001	Key Portable Hand Lamp	IP20	1	12
BA1-2001-0001	Keyless Portable Hand Lamp	IP20	1	12
BA1-1001-1031	Key 7,5 mt. Cabled Portable Hand Lamp	IP20	1	6
BA1-2001-1031	Keyless 7,5 mt. Cabled Portable Hand Lamp	IP20	1	6
BA1-1001-1021	Key 7,5 mt. Cabled Portable Hand Lamp	IP20	1	6

Product Code	Description	IP	Box	Pack
BA2-0110-0121	24V. 100W. Transformer Portable Hand Lamp	IP20	1	0
BA2-0210-0121	24V. 200W. Transformer	IP20	1	0
BA2-0111-1121	24V. 100W. Transformer Portable Hand Lamp	IP20	1	0
BA2-0211-1121	24V. 200W. Transformer	IP20	1	0



Key Portable Hand Lamp
BA1-1001-0001



Keyless Portable Hand Lamp
BA1-2001-0001



Key 7,5mt. Cabled
Portable Hand Lamp
BA1-1001-1031



Keyless 7,5mt. Cabled
Portable Hand Lamp
BA1-2001-1031



Key 7,5mt. 2x1mm Cabled
Portable Hand Lamp 24V. Plug
BA1-1001-1021



24V. 100W. Transformer
Portable Hand Lamp
BA2-0111-1121



24V. 100W. Transformer
BA2-0110-0121



24V. 200W. Transformer
Portable Hand Lamp
BA2-0211-1121



24V. 200W. Transformer
BA2-0210-0121



V5 Combinations (120x255x122)

Product Code	Description	IP	Box	Pack
BD1-2000-0000	V Automat Rail and 1 Terminal	IP44	1	12
BD1-2101-0000	Empty Box 1 Pc. Hole	IP44	1	12
BD1-2101-2020	Front 1 Pc.Hole 1/16A 220V 2 Pcs. Side	IP44	1	12
BD1-2105-1020	3/25A. 380V. 1 Pcs. Front 1/16A. 220V. 1 Pcs. Side	IP44	1	12
BD1-2105-2020	3/25A. 380V. 1 Pcs. Front 1/16A. 220V. 2 Pcs. Side	IP44	1	12
BD1-2118-2020	5/16A. 380V. 1 Pcs. Front 1/16A. 220V. 2 Pcs. Side	IP44	1	12
BD1-2134-2020	5/32A. 380V. 1 Pcs. Front 1/16A. 220V. 2 Pcs. Side	IP44	1	12
BD1-2202-0000	1/16A. 220V. 2 Pcs. Front	IP44	1	12
BD1-2202-2020	1/16A. 220V. 2 Pcs. Front 1/16A. 220V. 2 Pcs. Side	IP44	1	12
BD1-6000-0000	V Automat Rail and 1 Terminal	IP66	1	12
BD1-6114-2020	5/16A. 380V. IP67 1 Pcs. Front 1/16A. 220V. IP68 2 Pcs. Side	IP66	1	12
BD1-6130-2020	5/32A. 380V. IP67 1 Pcs. Front 1/16A. 220V. IP68 2 Pcs. Side	IP66	1	12



V7 Combinations (155x255x138)

Product Code	Description	IP	Box	Pack
BD5-2000-0000	V Automat Rail and 1 Terminal	IP44	1	12
BD5-2101-0000	Empty Box 1 Pc. Hole	IP44	1	12
BD5-2101-2020	Front 1 Pcs. Hole - Side 2 Pcs. 1/16A. 220V.	IP44	1	12
BD5-2105-2020	Front 1 Pcs. 3/25A. 380V. Side 2 Pcs. 1/16A. 220V.	IP44	1	12
BD5-2118-2020	Front 1 Pcs. 5/16A. 380V. Side 2 Pcs. 1/16A. 220V.	IP44	1	12
BD5-2134-2020	Front 1 Pcs. 5/32A. 380V. Side 2 Pcs. 1/16A. 220V.	IP44	1	12
BD5-6000-0000	V Automat Rail and 1 Terminal	IP66	1	12
BD5-6114-2020	Front 1 Pcs. 5/16A. 380V. Side 2 Pcs. 1/16A. 220V.	IP66	1	12
BD5-6130-2020	Front 1 Pcs. 5/32A. 380V. Side 2 Pcs. 1/16A. 220V.	IP66	1	12



V10 Combinations (210x300x122)

Product Code	Description	IP	Box	Pack
BD2-2000-0000	V Automat Rail and 2 Terminal	IP44	1	6
BD2-2201-0000	Front 2 Pcs. Empty Box 1 Pc. Hole	IP44	1	6
BD2-2201-2010	Front 2 Pcs. Hole Side 2 Pcs. Hole	IP44	1	6
BD2-2201-2020	Front 2 Pcs. Hole Side 2 Pcs. 1/16A. 220V.	IP44	1	6
BD2-2205-2020	Front 2 Pcs. 3/25A. 380V. Side 2 Pcs. 1/16A. 220V.	IP44	1	6
BD2-2218-2020	Front 2 Pcs. 5/16A. 380V. Side 2 Pcs. 1/16A. 220V.	IP44	1	6
BD2-2228-2020	Front 2 Pcs. 4/32A. 380V. Side 2 Pcs. 1/16A. 220V.	IP44	1	6
BD2-2234-2020	Front 2 Pcs. 5/32A. 380V. Side 2 Pcs. 1/16A. 220V.	IP44	1	6
BD2-6000-0000	V Automat Rail and 2 Terminal	IP66	1	6
BD2-6129-2020	Front 5/32A. 380V. 45° Angled M.P. 1 Pcs. - Side 1/16A. 220V. 2 Pcs.	IP66	1	6
BD2-6130-1142	Front 1 Pcs. 5/32A. 380V. 1 Pcs. 5/16A. 380V. - Side 2 Pcs. 1/16A. 220V.	IP66	1	6
BD2-6130-2020	Front 1 Pcs. 5/32A. 380V. - Side 2 Pcs. 1/16A. 220V.	IP66	1	6
BD2-6214-2020	Front 2 Pcs. 5/16A. 380V. - Side 2 Pcs. 1/16A. 220V.	IP66	1	6
BD2-6230-2020	Front 2 Pcs. 5/32A. 380V. - Side 2 Pcs. 1/16A. 220V.	IP66	1	6



BD6-2000-0000 | BD6-2118-2020 | BD6-2201-2010 | BD6-2201-2020 | BD6-2205-2020 | BD6-2218-2020 | BD6-2234-2020 | BD6-6000-0000 | BD6-6230-2020

V12 Combinations (245x325x138)

Product Code	Description	IP	Box	Pack
BD6-2000-0000	V Automat Rail and 2 Terminal	IP44	1	6
BD6-2201-0000	Front 2 Pcs. Empty Box 1 Pc. Hole	IP44	1	6
BD6-2201-2010	Front 2 Pcs. Hole Side 2 Pcs. Empty Box 1 Pc. Hole	IP44	1	6
BD6-2201-2020	Front 2 Pcs. Hole 2 Pcs. Side 1/16A. 220V.	IP44	1	6
BD6-2205-2020	Front 2 Pcs. 3/25A. 380V. Side 2 Pcs. 1/16A. 220V.	IP44	1	6
BD6-2218-2020	Front 2 Pcs. 5/16A. 380V. Side 2Pcs. 1/16A. 220V.	IP44	1	6
BD6-2234-2020	Front 2 Pcs. 5/32A. 380V. Side 2 Pcs. 1/16A. 220V.	IP44	1	6
BD6-6000-0000	V Automat Rail and 2 Terminal	IP66	1	6
BD6-6230-2020	Front 2 Pcs. 5/32A. 380V. Side 2 Pcs. 1/16A. 220V.	IP66	1	6



BD4-2000-0000 | BD4-2201-2010 | BD4-2218-2020 | BD4-2218-4020 | BD4-2234-2020 | BD4-2301-0000 | BD4-2305-2020 | BD4-2334-2020 | BD4-6000-0000 | BD4-6230-4020

V17 Combinations (340x340x140)

Product Code	Description	IP	Box	Pack
BD4-2000-0000	V Automat Rail Empty Box	IP44	1	5
BD4-2201-2010	Front 2 Pcs. Hole Side 2 Pcs. Hole	IP44	1	5
BD4-2218-2020	Front 2 Pcs. 5/16A. 380V. Side 2 Pcs. 1/16A. 220V.	IP44	1	5
BD4-2234-2020	Front 2 Pcs. 5/32A. 380V. Side 2Pcs. 1/16A. 220V.	IP44	1	5
BD4-2301-0000	Front 3 Pcs. Hole Empty Combinations	IP44	1	5
BD4-2305-2020	Front 3 Pcs. 3/25A. 380V. Side 2 Pcs. 1/16A. 220V.	IP44	1	5
BD4-2334-2020	Front 3 Pcs. 5/32A. 380V. Side 2 Pcs. 1/16A. 220V.	IP44	1	5
BD4-6000-0000	V Automat Rail Empty Box	IP66	1	5
BD4-6230-4020	Front 2 Pcs. 5/32A. 380V. Side 4 Pcs. 1/16A. 220V.	IP66	1	5



BD8-2000-0000 | BD8-2234-2020 | BD8-2301-0000 | BD8-2405-4020 | BD8-2434-2020 | BD8-2434-4020 | BD8-6000-0000 | BD8-6230-8030 | BD8-6401-0000 | BD8-6630-4020

V26 Combinations (300x535x145)

Product Code	Description	IP	Box	Pack
BD8-2000-0000	2 Pcs. V Automat Rail Empty Box	IP44	2	0
BD8-2405-4020	Front 4 Pcs. 3/25A. 380V. Front 4 Pcs. 1/16A. 220V. Panel Socket	IP44	2	0
BD8-2434-2020	Front 4 Pcs. 5/32A. 380V. Front 2 Pcs. 1/16A. 220V. Panel Socket	IP44	2	0
BD8-2434-4020	Front 4 Pcs. 5/32A. 380V. Front 4 Pcs. 1/16A. 220V. Panel Socket	IP44	2	0
BD8-6000-0000	2 Pcs. V Automat Rail Empty Box	IP66	2	0
BD8-6630-4020	Front 6 Pcs. 5/32A. 380V. Side 4 Pcs. 1/16A. 220V.	IP66	2	0



BH1-2000-0000 BH1-2101-2020 BH1-2105-1020 BH1-2105-2020 BH1-2118-2020 BH1-2134-2020 BH1-2202-0000 BH1-2202-2020 BH1-6000-0000

V5 Halogen Free Combinations (120x255x122)

Product Code	Description	IP	Box	Pack
BH1-2000-0000	V Automat Rail and 1 Terminal	IP44	1	12
BH1-2101-0000	Empty Box 1 Pc. Hole	IP44	1	12
BH1-2101-2020	Front 1 Pc.Hole 1/16A 220V 2 Pcs. Side	IP44	1	12
BH1-2105-1020	3/25A. 380V. 1 Pcs. Front 1/16A. 220V. 1 Pcs. Side	IP44	1	12
BH1-2105-2020	3/25A. 380V. 1 Pcs. Front 1/16A. 220V. 2 Pcs. Side	IP44	1	12
BH1-2118-2020	5/16A. 380V. 1 Pcs. Front 1/16A. 220V. 2 Pcs. Side	IP44	1	12
BH1-2134-2020	5/32A. 380V. 1 Pcs. Front 1/16A. 220V. 2 Pcs. Side	IP44	1	12
BH1-2202-0000	1/16A. 220V. 2 Pcs. Front	IP44	1	12
BH1-2202-2020	1/16A. 220V. 2 Pcs. Front 1/16A. 220V. 2 Pcs. Side	IP44	1	12
BH1-6000-0000	V Automat Rail and 1 Terminal	IP66	1	12
BH1-6114-2020	5/16A. 380V. IP67 1 Pcs. Front 1/16A. 220V. IP68 2 Pcs. Side	IP66	1	12
BH1-6130-2020	5/32A. 380V. IP67 1 Pcs. Front 1/16A. 220V. IP68 2 Pcs. Side	IP66	1	12



BH5-2000-0000 BH5-2101-0000 BH5-2101-2020 BH5-2105-2020 BH5-2118-2020 BH5-2134-2020 BH5-6000-0000 BH5-6114-2020 BH5-6130-2020

V7 Halogen Free Combinations (155x255x138)

Product Code	Description	IP	Box	Pack
BH5-2000-0000	V Automat Rail and 1 Terminal	IP44	1	12
BH5-2101-0000	Empty Box 1 Pc. Hole	IP44	1	12
BH5-2101-2020	Front 1 Pcs. Hole - Side 2 Pcs. 1/16A. 220V.	IP44	1	12
BH5-2105-2020	Front 1 Pcs. 3/25A. 380V. Side 2 Pcs. 1/16A. 220V.	IP44	1	12
BH5-2118-2020	Front 1 Pcs. 5/16A. 380V. Side 2 Pcs. 1/16A. 220V.	IP44	1	12
BH5-2134-2020	Front 1 Pcs. 5/32A. 380V. Side 2 Pcs. 1/16A. 220V.	IP44	1	12
BH5-6000-0000	V Automat Rail and 1 Terminal	IP66	1	12
BH5-6114-2020	Front 1 Pcs. 5/16A. 380V. Side 2 Pcs. 1/16A. 220V.	IP66	1	12
BH5-6130-2020	Front 1 Pcs. 5/32A. 380V. Side 2 Pcs. 1/16A. 220V.	IP66	1	12



BH2-2000-0000 BH2-2201-0000 BH2-2201-2020 BH2-2205-2020 BH2-2218-2020 BH2-2228-2020 BH2-2234-2020 BH2-6000-0000 BH2-6130-2020

V10 Halogen Free Combinations (210x300x122)

Product Code	Description	IP	Box	Pack
BH2-2000-0000	V Automat Rail and 2 Terminal	IP44	1	6
BH2-2201-0000	Front 2 Pcs. Empty Box 1 Pc. Hole	IP44	1	6
BH2-2201-2010	Front 2 Pcs. Hole Side 2 Pcs. Hole	IP44	1	6
BH2-2201-2020	Front 2 Pcs. Hole Side 2 Pcs. 1/16A. 220V.	IP44	1	6
BH2-2205-2020	Front 2 Pcs. 3/25A. 380V. Side 2 Pcs. 1/16A. 220V.	IP44	1	6
BH2-2218-2020	Front 2 Pcs. 5/16A. 380V. Side 2 Pcs. 1/16A. 220V.	IP44	1	6
BH2-2228-2020	Front 2 Pcs. 4/32A. 380V. Side 2 Pcs. 1/16A. 220V.	IP44	1	6
BH2-2234-2020	Front 2 Pcs. 5/32A. 380V. Side 2 Pcs. 1/16A. 220V.	IP44	1	6
BH2-6000-0000	V Automat Rail and 2 Terminal	IP66	1	6
BH2-6129-2020	Front 5/32A. 380V. 45° Angled M.P. 1 Pcs. - Side 1/16A. 220V. 2 Pcs.	IP66	1	6
BH2-6130-1142	Front 1 Pcs. 5/32A. 380V. 1 Pcs. 5/16A. 380V. - Side 2 Pcs. 1/16A. 220V.	IP66	1	6
BH2-6130-2020	Front 1 Pcs. 5/32A. 380V. - Side 2 Pcs. 1/16A. 220V.	IP66	1	6
BH2-6214-2020	Front 2 Pcs. 5/16A. 380V. - Side 2 Pcs. 1/16A. 220V.	IP66	1	6
BH2-6230-2020	Front 2 Pcs. 5/32A. 380V. - Side 2 Pcs. 1/16A. 220V.	IP66	1	6



BH6-2000-0000 | BH6-2118-2020 | BH6-2201-2010 | BH6-2201-2020 | BH6-2205-2020 | BH6-2218-2020 | BH6-2234-2020 | BH6-6000-0000 | BH6-6230-2020

V12 Halogen Free Combinations (245x325x138)

Product Code	Description	IP	Box	Pack
BH6-2000-0000	V Automat Rail and 2 Terminal	IP44	1	6
BH6-2201-0000	Front 2 Pcs. Empty Box 1 Pc. Hole	IP44	1	6
BH6-2201-2010	Front 2 Pcs. Hole Side 2 Pcs. Empty Box 1 Pc. Hole	IP44	1	6
BH6-2201-2020	Front 2 Pcs. Hole 2 Pcs. Side 1/16A. 220V.	IP44	1	6
BH6-2205-2020	Front 2 Pcs. 3/25A. 380V. Side 2 Pcs. 1/16A. 220V.	IP44	1	6
BH6-2218-2020	Front 2 Pcs. 5/16A. 380V. Side 2Pcs. 1/16A. 220V.	IP44	1	6
BH6-2234-2020	Front 2 Pcs. 5/32A. 380V. Side 2 Pcs. 1/16A. 220V.	IP44	1	6
BH6-6000-0000	V Automat Rail and 2 Terminal	IP66	1	6
BH6-6230-2020	Front 2 Pcs. 5/32A. 380V. Side 2 Pcs. 1/16A. 220V.	IP66	1	6



BH4-2000-0000 | BH4-2201-2010 | BH4-2218-2020 | BH4-2218-4020 | BH4-2234-2020 | BH4-2301-0000 | BH4-2305-2020 | BH4-2334-2020 | BH4-6000-0000 | BH4-6230-4020

V17 Halogen Free Combinations (340x340x140)

Product Code	Description	IP	Box	Pack
BH4-2000-0000	V Automat Rail Empty Box	IP44	1	5
BH4-2201-2010	Front 2 Pcs. Hole Side 2 Pcs. Hole	IP44	1	5
BH4-2218-2020	Front 2 Pcs. 5/16A. 380V. Side 2 Pcs. 1/16A. 220V.	IP44	1	5
BH4-2234-2020	Front 2 Pcs. 5/32A. 380V. Side 2Pcs. 1/16A. 220V.	IP44	1	5
BH4-2301-0000	Front 3 Pcs. Hole Empty Combinations	IP44	1	5
BH4-2305-2020	Front 3 Pcs. 3/25A. 380V. Side 2 Pcs. 1/16A. 220V.	IP44	1	5
BH4-2334-2020	Front 3 Pcs. 5/32A. 380V. Side 2 Pcs. 1/16A. 220V.	IP44	1	5
BH4-6000-0000	V Automat Rail Empty Box	IP66	1	5
BH4-6230-4020	Front 2 Pcs. 5/32A. 380V. Side 4 Pcs. 1/16A. 220V.	IP66	1	5

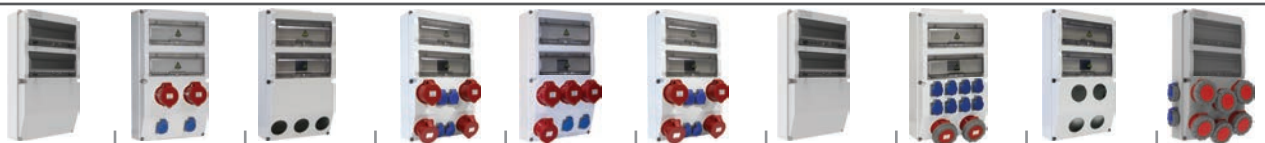

BH8-2000-0000 | BH8-2234-2020 | BH8-2301-0000 | BH8-2405-4020 | BH8-2434-2020 | BH8-2434-4020 | BH8-6000-0000 | BH8-6230-8030 | BH8-6401-0000 | BH8-6630-4020

V26 Halogen Free Combinations (300x535x145)

Product Code	Description	IP	Box	Pack
BH8-2000-0000	2 Pcs. V Automat Rail Empty Box	IP44	2	0
BH8-2405-4020	Front 4 Pcs. 3/25A. 380V. Front 4 Pcs. 1/16A. 220V. Panel Socket	IP44	2	0
BH8-2434-2020	Front 4 Pcs. 5/32A. 380V. Front 2 Pcs. 1/16A. 220V. Panel Socket	IP44	2	0
BH8-2434-4020	Front 4 Pcs. 5/32A. 380V. Front 4 Pcs. 1/16A. 220V. Panel Socket	IP44	2	0
BH8-6000-0000	2 Pcs. V Automat Rail Empty Box	IP66	2	0
BH8-6630-4020	Front 6 Pcs. 5/32A. 380V. Side 4 Pcs. 1/16A. 220V.	IP66	2	0

Mini Combinations (120x170x110)
IP44 / IP67 Our Models



BD7-2000-0000



BD7-2401-0000



BD7-2402-0000



BD7-2402-2020



BD7-2107-4020



BD7-2134-2020

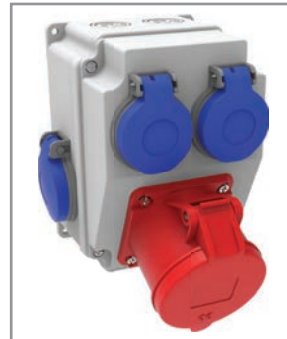

BD7-2134-4020



BD7-2107-1090

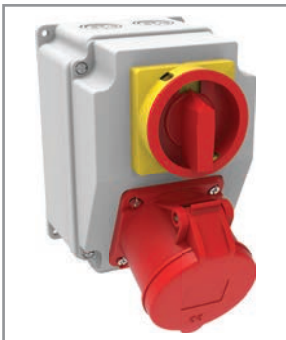

BD7-2134-1090



BD7-6103-4020



BD7-6103-1090



BD7-6130-1090



BD7-6114-2020



BD7-6130-2020



BD7-6114-1092



BD7-6130-1092

MINI COMBINATIONS (120x170x110)

Product Code	Description	IP	Box	Pack
BD7-2000-0000	Empty Combinations 120X170X110	IP44	1	16
BD7-2107-0000	Front 1 Pcs. 3/16A. 220V. Panel Mounted Socket	IP44	1	16
BD7-2107-1090	Front 1 Pcs. Pako Switch Front 1 Pcs. 3/16A. 220V. Panel Mounted Socket	IP44	1	16
BD7-2107-2020	Front 2 Pcs. 1/16A. 220V. Panel Socket Front 1 Pcs. 3/16A. 220V. Panel Mounted Socket	IP44	1	16
BD7-2112-0000	Front 1 Pcs. 4/16A. 380V. Panel Mounted Socket	IP44	1	16
BD7-2112-1090	Front 1 Pcs. Pako Switch Front 1 Pcs. 4/16A. 380V. Panel Mounted Socket	IP44	1	16
BD7-2112-2020	Front 2 Pcs. 1/16A. 220V. Panel Socket Front 1 Pcs. 4/16A. 380V. Panel Mounted Socket	IP44	1	16
BD7-2118-0000	Front 1 Pcs. 5/16A. 380V. Panel Mounted Socket	IP44	1	16
BD7-2118-1090	Front 1 Pcs. Pako Switch Front 1 Pcs. 5/16A. 380V. Panel Mounted Socket	IP44	1	16
BD7-2118-2020	Front 2 Pcs. 1/16A. 220V. Panel Socket Front 1 Pcs. 5/16A. 380V. Panel Mounted Socket	IP44	1	16
BD7-2123-0000	Front 1 Pcs. 3/32A. 220V. Panel Mounted Socket	IP44	1	16
BD7-2123-1090	Front 1 Pcs. Pako Switch Front 1 Pcs. 3/32A. 220V. Panel Mounted Socket	IP44	1	16
BD7-2123-2020	Front 2 Pcs. 1/16A. 220V. Panel Socket Front 1 Pcs. 3/32A. 220V. Panel Mounted Socket	IP44	1	16
BD7-2128-0000	Front 1 Pcs. 4/32A. 380V. Panel Mounted Socket	IP44	1	16
BD7-2128-1090	Front 1 Pcs. Pako Switch Front 1 Pcs. 4/32A. 380V. Panel Mounted Socket	IP44	1	16
BD7-2128-2020	Front 2 Pcs. 1/16A. 220V. Panel Socket Front 1 Pcs. 4/32A. 380V. Panel Mounted Socket	IP44	1	16
BD7-2134-0000	Front 1 Pcs. 5/32A. 380V. Panel Mounted Socket	IP44	1	16
BD7-2134-1090	Front 1 Pcs. Pako Switch Front 1 Pcs. 5/32A. 380V. Panel Mounted Socket	IP44	1	16
BD7-2134-2020	Front 2 Pcs. 1/16A. 220V. Panel Socket Front 1 Pcs. 5/32A. 380V. Panel Mounted Socket	IP44	1	16
BD7-2301-0000	Front 2 Pcs. Monofaze 1 Pcs. Trifaze Hole Empty Combinations	IP44	1	16
BD7-2401-0000	Front 4 Pcs. Hole Empty Combinations	IP44	1	16
BD7-2402-0000	Front 4 Pcs. 1/16A. 220V. Panel Socket	IP44	1	16
BD7-2402-2020	Front 4 Pcs. 1/16A. 220V. Side 2 Pcs. 1/16A. 220V. Panel Socket	IP44	1	16
BD7-6000-0000	Empty Combinations 120X170X110	IP66	1	16
BD7-6102-0000	Front 1 Pcs. 1/16A. 220V. Panel Socket	IP66	1	16
BD7-6102-1090	Front 1 Pcs. Pako Switch Front 1 Pcs. 1/16A. 220V. Panel Socket	IP65	1	16
BD7-6103-0000	Front 1 Pcs. 3/16A. 220V. Panel Mounted Socket	IP66	1	16
BD7-6103-1090	Front 1 Pcs. Pako Switch Front 1 Pcs. 3/16A. 220V. Panel Mounted Socket	IP65	1	16
BD7-6108-0000	Front 1 Pcs. 4/16A. 380V. Panel Mounted Socket	IP66	1	16
BD7-6108-1090	Front 1 Pcs. Pako Switch Front 1 Pcs. 4/16A. 380V. Panel Mounted Socket	IP65	1	16
BD7-6114-0000	Front 1 Pcs. 5/16A. 380V. Panel Mounted Socket	IP66	1	16
BD7-6114-1090	Front 1 Pcs. Pako Switch Front 1 Pcs. 5/16A. 380V. Panel Mounted Socket	IP65	1	16
BD7-6119-0000	Front 1 Pcs. 3/32A. 220V. Panel Mounted Socket	IP66	1	16
BD7-6119-1090	Front 1 Pcs. Pako Switch Front 1 Pcs. 3/32A. 220V. Panel Mounted Socket	IP65	1	16
BD7-6124-0000	Front 1 Pcs. 4/32A. 380V. Panel Mounted Socket	IP66	1	16
BD7-6124-1090	Front 1 Pcs. Pako Switch Front 1 Pcs. 4/32A. 380V. Panel Mounted Socket	IP65	1	16
BD7-6130-0000	Front 1 Pcs. 5/32A. 380V. Panel Mounted Socket	IP66	1	16
BD7-6130-1090	Front 1 Pcs. Pako Switch Front 1 Pcs. 5/32A. 380V. Panel Mounted Socket	IP65	1	16
BD7-6114-2020	Front 1 Pcs. 5/16A. 380V. Side 2 Pcs. 1/16A. 220V. Panel Mounted Socket	IP66	1	16
BD7-6130-2020	Front 1 Pcs. 5/32A. 380V. Side 2 Pcs. 1/16A. 220V. Panel Mounted Socket	IP66	1	16
BD7-6114-1092	Front 1 Pcs. Pako Switch 1 Pcs. 5/16A. 380V. Side 2 Pcs. 1/16A. 220V. Panel Mounted Socket	IP65	1	16
BD7-6130-1092	Front 1 Pcs. Pako Switch 1 Pcs. 5/32A. 380V. Side 2 Pcs. 1/16A. 220V. Panel Mounted Socket	IP65	1	16

Brand
New
Brand
New
Brand
New
Brand
New

Aluminum Combinations



BB4-2192-8210
230x330x140

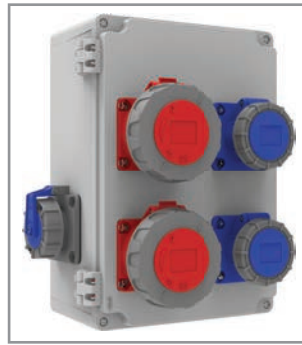

BB4-7192-8310
230x330x140



BB4-7192-8210
230x330x140



BB4-7191-8321
230x330x140

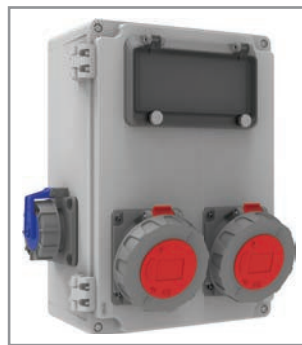

BB4-7192-J210
230x330x140

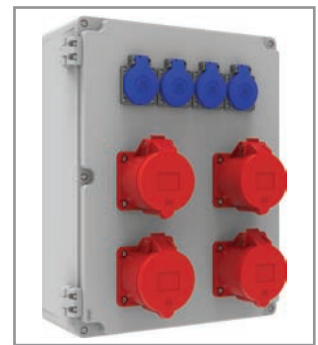

BB4-2184-8410
310x400x140



BB4-2182-8410
310x400x140

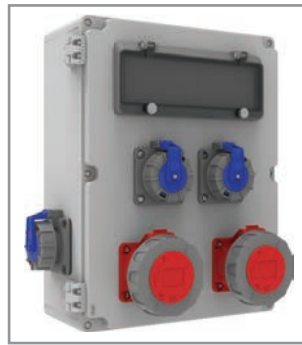

BB4-7182-8410
310x400x140



BB4-7183-8000
310x400x140



BB4-7162-H2F0
190x350x90

V5 Cable Mounted Combination Box

Product Code	Description	IP	Box	Pack
BD1M2134-2020	5/32A. 380V. 1 Pcs. Front - 1/16A. 220V. 2 Pcs. Side (ABS)	IP44	1	12
BD1M2118-2020	5/16A. 380V. 1 Pcs. Front - 1/16A. 220V. 2 Pcs. Side (ABS)	IP44	1	12
BD1M2105-2020	3/25A. 380V. 1 Pcs. Front - 1/16A. 220V. 2 Pcs. Side (ABS)	IP44	1	12
BH1M2134-2020	5/32A. 380V. 1 Pcs. Front - 1/16A. 220V. 2 Pcs. Side (ABS-H.F.)	IP44	1	12
BH1M2118-2020	5/16A. 380V. 1 Pcs. Front - 1/16A. 220V. 2 Pcs. Side (ABS-H.F.)	IP44	1	12
BH1M2105-2020	3/25A. 380V. 1 Pcs. Front - 1/16A. 220V. 2 Pcs. Side (ABS-H.F.)	IP44	1	12
BD1M6114-2020	5/16A. 380V. IP67 1 Pcs. Front - 1/16A. 220V. IP68 2 Pcs. Side (ABS)	IP66	1	12
BD1M6130-2020	5/32A. 380V. IP67 1 Pcs. Front - 1/16A. 220V. IP68 2 Pcs. Side (ABS)	IP66	1	12
BH1M6114-2020	5/16A. 380V. IP67 1 Pcs. Front - 1/16A. 220V. IP68 2 Pcs. Side (ABS-H.F.)	IP66	1	12
BH1M6130-2020	5/32A. 380V. IP67 1 Pcs. Front - 1/16A. 220V. IP68 2 Pcs. Side (ABS-H.F.)	IP66	1	12

V7 Cable Mounted Combination Box

Product Code	Description	IP	Box	Pack
BD5M2134-2020	5/32A. 380V. 1 Pcs. Front - 1/16A. 220V. 2 Pcs. Side (ABS)	IP44	1	12
BD5M2118-2020	5/16A. 380V. 1 Pcs. Front - 1/16A. 220V. 2 Pcs. Side (ABS)	IP44	1	12
BD5M2105-2020	3/25A. 380V. 1 Pcs. Front - 1/16A. 220V. 2 Pcs. Side (ABS)	IP44	1	12
BD5M6114-2020	5/16A. 380V. 1 Pcs. Front - 1/16A. 220V. 2 Pcs. Side (ABS)	IP66	1	12
BD5M6130-2020	5/32A. 380V. 1 Pcs. Front - 1/16A. 220V. 2 Pcs. Side (ABS)	IP66	1	12
BH5M2134-2020	5/32A. 380V. 1 Pcs. Front - 1/16A. 220V. 2 Pcs. Side (ABS-H.F.)	IP44	1	12
BH5M2118-2020	5/16A. 380V. 1 Pcs. Front - 1/16A. 220V. 2 Pcs. Side (ABS-H.F.)	IP44	1	12
BH5M2105-2020	3/25A. 380V. 1 Pcs. Front - 1/16A. 220V. 2 Pcs. Side (ABS-H.F.)	IP44	1	12
BH5M6114-2020	5/16A. 380V. 1 Pcs. Front - 1/16A. 220V. 2 Pcs. Side (ABS-H.F.)	IP66	1	12
BH5M6130-2020	5/32A. 380V. 1 Pcs. Front - 1/16A. 220V. 2 Pcs. Side (ABS-H.F.)	IP66	1	12

V10 Cable Mounted Combination Box

Product Code	Description	IP	Box	Pack
BD2M2234-2020	5/32A. 380V. 2 Pcs. Front - 1/16A. 220V. 2 Pcs. Side (ABS)	IP44	1	6
BD2M2218-2020	5/16A. 380V. 2 Pcs. Front - 1/16A. 220V. 2 Pcs. Side (ABS)	IP44	1	6
BD2M2205-2020	3/25A. 380V. 2 Pcs. Front - 1/16A. 220V. 2 Pcs. Side (ABS)	IP44	1	6
BH2M2234-2020	5/32A. 380V. 2 Pcs. Front - 1/16A. 220V. 2 Pcs. Side (ABS-H.F.)	IP44	1	6
BH2M2218-2020	5/16A. 380V. 2 Pcs. Front - 1/16A. 220V. 2 Pcs. Side (ABS-H.F.)	IP44	1	6
BH2M2205-2020	3/25A. 380V. 2 Pcs. Front - 1/16A. 220V. 2 Pcs. Side (ABS-H.F.)	IP44	1	6
BD2M6214-2020	5/16A. 380V. IP67 2 Pcs. Front - 1/16A. 220V. IP68 2 Pcs. Side (ABS)	IP66	1	6
BD2M6230-2020	5/32A. 380V. IP67 2 Pcs. Front - 1/16A. 220V. IP68 2 Pcs. Side (ABS)	IP66	1	6
BH2M6214-2020	5/16A. 380V. IP67 2 Pcs. Front - 1/16A. 220V. IP68 2 Pcs. Side (ABS-H.F.)	IP66	1	6
BH2M6230-2020	5/32A. 380V. IP67 2 Pcs. Front - 1/16A. 220V. IP68 2 Pcs. Side (ABS-H.F.)	IP66	1	6

V12 Cable Mounted Combination Box

Product Code	Description	IP	Box	Pack
BD6M2234-2020	5/32A. 380V. 2 Pcs. Front - 1/16A. 220V. 2 Pcs. Side (ABS)	IP44	1	6
BD6M2218-2020	5/16A. 380V. 2 Pcs. Front - 1/16A. 220V. 2 Pcs. Side (ABS)	IP44	1	6
BD6M2205-2020	3/25A. 380V. 2 Pcs. Front - 1/16A. 220V. 2 Pcs. Side (ABS)	IP44	1	6
BD6M6214-2020	5/16A. 380V. 2 Pcs. Front - 1/16A. 220V. 2 Pcs. M.P. Side (ABS)	IP66	1	6
BD6M6230-2020	5/32A. 380V. 2 Pcs. Front - 1/16A. 220V. 2 Pcs. M.P. Side (ABS)	IP66	1	6
BH6M2234-2020	5/32A. 380V. 2 Pcs. Front - 1/16A. 220V. 2 Pcs. Side (ABS-H.F.)	IP44	1	6
BH6M2218-2020	5/16A. 380V. 2 Pcs. Front - 1/16A. 220V. 2 Pcs. Side (ABS-H.F.)	IP44	1	6
BH6M2205-2020	3/25A. 380V. 2 Pcs. Front - 1/16A. 220V. 2 Pcs. Side (ABS-H.F.)	IP44	1	6
BH6M6214-2020	5/16A. 380V. 2 Pcs. Front - 1/16A. 220V. 2 Pcs. M.P. Side (ABS-H.F.)	IP66	1	6
BH6M6230-2020	5/32A. 380V. 2 Pcs. Front - 1/16A. 220V. 2 Pcs. M.P. Side (ABS-H.F.)	IP66	1	6

V17 Cable Mounted Combination Box

Product Code	Description	IP	Box	Pack
BD4M2334-2020	5/32A. 380V. 3 Pcs. Front - 1/16A. 220V. 2 Pcs. Side (ABS)	IP44	1	2
BD4M2318-2020	5/16A. 380V. 3 Pcs. Front - 1/16A. 220V. 2 Pcs. Side (ABS)	IP44	1	2
BD4M2305-2020	3/25A. 380V. 3 Pcs. Front - 1/16A. 220V. 2 Pcs. Side (ABS)	IP44	1	2
BD4M6314-2020	5/16A. 380V. 3 Pcs. Front - 1/16A. 220V. 2 Pcs. M.P. Side (ABS)	IP66	1	2
BD4M6330-2020	5/32A. 380V. 3 Pcs. Front - 1/16A. 220V. 2 Pcs. M.P. Side (ABS)	IP66	1	2
BH4M2334-2020	5/32A. 380V. 3 Pcs. Front - 1/16A. 220V. 2 Pcs. Side (ABS-H.F.)	IP44	1	2
BH4M2318-2020	5/16A. 380V. 3 Pcs. Front - 1/16A. 220V. 2 Pcs. Side (ABS-H.F.)	IP44	1	2
BH4M2305-2020	3/25A. 380V. 3 Pcs. Front - 1/16A. 220V. 2 Pcs. Side (ABS-H.F.)	IP44	1	2
BH4M6314-2020	5/16A. 380V. 3 Pcs. Front - 1/16A. 220V. 2 Pcs. M.P. Side (ABS-H.F.)	IP66	1	2
BH4M6330-2020	5/32A. 380V. 3 Pcs. Front - 1/16A. 220V. 2 Pcs. M.P. Side (ABS-H.F.)	IP66	1	2

V26 Cable Mounted Combination Box

Product Code	Description	IP	Box	Pack
BD8M2405-4020	4 Pcs. 3/25A. 380V. Front - 4 Pcs. 1/16A. 220V. Front Panel Socket (ABS)	IP44	1	0
BD8M2434-4020	4 Pcs. 5/32A. 380V. Front - 4 Pcs. 1/16A. 220V. Front Panel Socket (ABS)	IP44	1	0
BD8M2418-4020	5/16A. 380V. 4 Pcs. Front - 1/16A. 220V. 4 Pcs. Side (ABS)	IP44	1	0
BD8M6230-8030	2 Pcs. 5/32A. 380V. Front - 8 Pcs. 1/16A. 220V. Front Panel Socket (ABS)	IP66	1	0
BD8M6414-4020	5/16A. 380V. 4 Pcs. Front - 1/16A. 220V. 4 Pcs. Side (ABS)	IP66	1	0
BH8M2405-4020	4 Pcs. 3/25A. 380V. Front - 4 Pcs. 1/16A. 220V. Front Panel Socket (ABS-H.F.)	IP44	1	0
BH8M2434-4020	4 Pcs. 5/32A. 380V. Front - 4 Pcs. 1/16A. 220V. Front Panel Socket (ABS-H.F.)	IP44	1	0
BH8M2418-4020	5/16A. 380V. 4 Pcs. Front - 1/16A. 220V. 4 Pcs. Side (ABS-H.F.)	IP44	1	0
BH8M6230-8030	2 Pcs. 5/32A. 380V. Front - 8 Pcs. 1/16A. 220V. Front Panel Socket (ABS-H.F.)	IP66	1	0
BH8M6414-4020	5/16A. 380V. 4 Pcs. Front - 1/16A. 220V. 4 Pcs. Side (ABS-H.F.)	IP66	1	0

Combinations with wheeled

Product Code	Description	IP	Box	Pack
BD8A2000-0000	Empty Combination box	IP44	1	0
BD8A2234-4020	5/32A. 380V. 2 Pcs. - 1/16A. 220V. 4 Pcs.	IP44	1	0
BD8A2434-4020	5/32A. 380V. 4 Pcs. - 1/16A. 220V. 4 Pcs.	IP44	1	0
BD8A2418-4020	5/16A. 380V. 4 Pcs. - 1/16A. 220V. 4 Pcs.	IP44	1	0
BD8A6224-4020	4/32A. 380V. 2 Pcs. - 1/16A. 220V. 4 Pcs.	IP66	1	0
BD8A6230-4020	5/32A. 380V. 2 Pcs. - 1/16A. 220V. 4 Pcs.	IP66	1	0

**Brand
New**



ABS. BOARD

Product Code	Description	IP	Box	Pack
BPA-1001-0016	200x300x130 mm	IP66	1	0
BPA-2001-0026	250x350x150 mm	IP66	1	0
BPA-3001-0036	300x400x170 mm	IP66	1	0
BPA-3001-0106	300x400x220 mm	IP66	1	0
BPA-4001-0046	350x500x190 mm	IP66	1	0
BPA-5001-0056	400x500x180 mm	IP66	1	0
BPA-6001-0066	400x500x240 mm	IP66	1	0
BPA-7001-0076	400x600x200 mm	IP66	1	0
BPA-1101-0116	500x600x220 mm	IP66	1	0
BPA-8001-0086	500x700x250 mm	IP66	1	0
BPA-9001-0096	600x800x260 mm	IP66	1	0

Opaque Cover ABS Board

Product Code	Description	IP	Box	Pack
BPC-1001-0016	200x300x130 mm	IP66	1	0
BPC-2001-0026	250x350x150 mm	IP66	1	0
BPC-3001-0036	300x400x170 mm	IP66	1	0
BPC-3001-0106	300x400x220 mm	IP66	1	0
BPC-4001-0046	350x500x190 mm	IP66	1	0
BPC-5001-0056	400x500x180 mm	IP66	1	0
BPC-6001-0066	400x500x240 mm	IP66	1	0
BPC-7001-0076	400x600x200 mm	IP66	1	0
BPC-1101-0116	500x600x220 mm	IP66	1	0
BPC-8001-0086	500x700x250 mm	IP66	1	0
BPC-9001-0096	600x800x260 mm	IP66	1	0

Transparent Cover ABS Board



Transparent Cover ABS Board

- 650°C durable fireproof body
- Halogen free

IK 10
IP 66

5 YEARS WARRANTY

CE



Opaque Cover ABS Board

Plastic Enclosure Box

ABS / Halogen Free / IP44



Product Code	Description	IP	Box	Pack
BB1-0141-0003	Diameter 70mm. Press Lid	IP44	27	324
BB1-0241-0003	Diameter 90mm. Press Lid	IP44	20	240
BB1-0341-0003	85mm x 85mm x 50mm Press Lid	IP44	75	0
BB1-0441-0003	95mm x 95mm x 50mm Press Lid	IP44	8	144
BB1-0431-0083	95mm x 95mm x 60mm Screw lid	IP44	8	96
BB1-1231-0023	110mm x 110mm x 70mm Screw lid	IP44	6	72
BB1-1331-0023	110mm x 150mm x 70mm Screw lid	IP44	4	48
BB1-1131-0053	110mm x 110mm x 100mm Screw lid	IP44	4	72
BB1-1121-0053	110mm x 110mm x 100mm Transparent Cover	IP44	4	72
BB1-0531-0003	120mm x 120mm x 70mm Screw lid	IP44	6	72
BB1-0521-0063	120mm x 120mm x 140mm Transparent Cover	IP44	1	60
BB1-0531-0063	120mm x 120mm x 140mm Screw lid	IP44	1	60
BB1-0921-0023	120mm x 170mm x 70mm Transparent Cover	IP44	15	-
BB1-0931-0023	120mm x 170mm x 70mm Screw lid	IP44	15	-
BB1-0921-0063	120mm x 170mm x 140mm Transparent Cover	IP44	1	40
BB1-0931-0063	120mm x 170mm x 140mm Screw lid	IP44	1	40
BB1-0621-0063	120mm x 224mm x 140mm Transparent Cover	IP44	1	30
BB1-0631-0063	120mm x 224mm x 140mm Screw lid	IP44	1	30
BB1-0631-0003	120mm x 255mm x 80mm Screw lid	IP44	10	0
BB1-0731-0003	210mm x 300mm x 90mm Screw lid	IP44	4	0
BB1-0721-0063	220mm x 300mm x 140mm Transparent Cover	IP44	1	10
BB1-0731-0063	220mm x 300mm x 140mm Screw lid	IP44	1	10
BB1-1231-0092	300mm x 535mm x 150mm Screw lid	IP44	2	0
BB1-1221-0092	300mm x 535mm x 150mm Transparent Cover	IP44	2	0
BB1-1021-0073	340mm x 340mm x 160mm Transparent Cover	IP44	1	6
BB1-1031-0073	340mm x 340mm x 160mm Screw lid	IP44	1	6

70 mm  BB2-0141-0003 Halogen Free IP44 BB1-0141-0003	90 mm  BB2-0241-0003 Halogen Free IP44 BB1-0241-0003	85x85x50  BB2-0341-0003 Halogen Free IP44 BB1-0341-0003	95x95x50  BB2-0441-0003 Halogen Free IP44 BB1-0441-0003	95x95x60  BB2-0431-0083 / IP44 BB2-0431-0086 / IP67 Halogen Free BB1-0431-0083 / IP44 BB1-0431-0086 / IP67	110x110x70  BB2-1231-0023 / IP44 BB2-1231-0026 / IP67 Halogen Free BB1-1231-0023 / IP44 BB1-1231-0026 / IP67
110x110x100  BB2-1131-0053 / IP44 BB2-1131-0056 / IP67 Halogen Free BB1-1131-0053 / IP44 BB1-1131-0056 / IP67	110x110x100  BB2-1121-0053 / IP44 BB2-1121-0056 / IP67 Halogen Free BB1-1121-0053 / IP44 BB1-1121-0056 / IP67	120x120x70  BB2-0531-0003 / IP44 BB2-0531-0006 / IP67 Halogen Free BB1-0531-0003 / IP44 BB1-0531-0006 / IP67	120x120x140  BB2-0531-0063 / IP44 BB2-0531-0066 / IP67 Halogen Free BB1-0531-0063 / IP44 BB1-0531-0066 / IP67	120x120x140  BB2-0521-0063 / IP44 BB2-0521-0066 / IP67 Halogen Free BB1-0521-0063 / IP44 BB1-0521-0066 / IP67	110x150x70  BB2-1331-0023 / IP44 BB2-1331-0026 / IP67 Halogen Free BB1-1331-0023 / IP44 BB1-1331-0026 / IP67

Product Code	Description	IP	Box	Pack
BB2-0141-0003	Diameter 70mm. Press Lid	IP44	27	324
BB2-0241-0003	Diameter 90mm. Press Lid	IP44	20	240
BB2-0341-0003	85mm x 85mm x 50mm Press Lid	IP44	75	0
BB2-0431-0083	95mm x 95mm x 60mm Screw lid	IP44	8	96
BB2-0441-0003	95mm x 95mm x 50mm Press Lid	IP44	8	144
BB2-1231-0023	110mm x 110mm x 70mm Screw lid	IP44	6	72
BB2-1331-0023	110mm x 150mm x 70mm Screw lid	IP44	4	48
BB2-1131-0053	110mm x 110mm x 100mm Screw lid	IP44	4	72
BB2-1121-0053	110mm x 110mm x 100mm Transparent Cover	IP44	4	72
BB2-0531-0003	120mm x 120mm x 70mm Screw lid	IP44	6	72
BB2-0521-0063	120mm x 120mm x 140mm Transparent Cover	IP44	1	60
BB2-0531-0063	120mm x 120mm x 140mm Screw lid	IP44	1	60
BB2-0921-0023	120mm x 170mm x 70mm Transparent Cover	IP44	15	-
BB2-0931-0023	120mm x 170mm x 70mm Screw lid	IP44	15	-
BB2-0921-0063	120mm x 170mm x 140mm Transparent Cover	IP44	1	40
BB2-0931-0063	120mm x 170mm x 140mm Screw lid	IP44	1	40
BB2-0621-0063	120mm x 224mm x 140mm Transparent Cover	IP44	1	30
BB2-0631-0063	120mm x 224mm x 140mm Screw lid	IP44	1	30
BB2-0631-0003	120mm x 255mm x 80mm Screw lid	IP44	10	0
BB2-0731-0003	210mm x 300mm x 90mm Screw lid	IP44	4	0
BB2-0721-0063	220mm x 300mm x 140mm Transparent Cover	IP44	1	10
BB2-0731-0063	220mm x 300mm x 140mm Screw lid	IP44	1	10
BB2-1231-0092	300mm x 535mm x 150mm Screw lid	IP44	2	0
BB2-1221-0092	300mm x 535mm x 150mm Transparent Cover	IP44	2	0
BB2-1021-0073	340mm x 340mm x 160mm Transparent Cover	IP44	1	6
BB2-1031-0073	340mm x 340mm x 160mm Screw lid	IP44	1	6

120x170x70



BB2-0931-0023 / IP44
BB2-0931-0026 / IP67

Halogen Free

BB1-0931-0023 / IP44
BB1-0931-0026 / IP67

120x170x70



BB2-0921-0023 / IP44
BB2-0921-0026 / IP67

Halogen Free

BB1-0921-0023 / IP44
BB1-0921-0026 / IP67

120x170x140



BB2-0931-0063 / IP44
BB2-0931-0066 / IP67

Halogen Free

BB1-0931-0063 / IP44
BB1-0931-0066 / IP67

120x170x140



BB2-0921-0063 / IP44
BB2-0921-0066 / IP67

Halogen Free

BB1-0921-0063 / IP44
BB1-0921-0066 / IP67

120x255x80



BB2-0631-0003 / IP44
BB2-0631-0006 / IP67

Halogen Free

BB1-0631-0003 / IP44
BB1-0631-0006 / IP67

120x225x140



BB2-0631-0063 / IP44
BB2-0631-0066 / IP67

Halogen Free

BB1-0631-0063 / IP44
BB1-0631-0066 / IP67

120x224x140



BB2-0621-0063 / IP44
BB2-0621-0066 / IP67

Halogen Free

BB1-0621-0063 / IP44
BB1-0621-0066 / IP67

210x300x90



BB2-0731-0003 / IP44
BB2-0731-0006 / IP67

Halogen Free

BB1-0731-0003 / IP44
BB1-0731-0006 / IP67

220x300x140



BB2-0731-0063 / IP44
BB2-0731-0066 / IP67

Halogen Free

BB1-0731-0063 / IP44
BB1-0731-0066 / IP67

220x300x140



BB2-0721-0063 / IP44
BB2-0721-0066 / IP67

Halogen Free

BB1-0721-0063 / IP44
BB1-0721-0066 / IP67

Plastic Enclosure Box

ABS / Halogen Free / IP67



Product Code	Description	IP	Box	Pack
BB1-1431-0006	Ø80x45mm. Screw lid	IP67	16	192
BB1-0431-0086	95mm x 95mm x 60mm Screw lid	IP67	8	96
BB1-1231-0026	110mm x 110mm x 70mm Screw lid	IP67	6	72
BB1-1131-0056	110mm x 110mm x 100mm Screw lid	IP67	4	72
BB1-1121-0056	110mm x 110mm x 100mm Transparent Cover	IP67	4	72
BB1-1331-0026	110mm x 150mm x 70mm Screw lid	IP67	4	48
BB1-0531-0006	120mm x 120mm x 70mm Screw lid	IP67	6	72
BB1-0531-0066	120mm x 120mm x 140mm Screw lid	IP67	1	60
BB1-0521-0066	120mm x 120mm x 140mm Transparent Cover	IP67	1	60
BB1-0931-0026	120mm x 170mm x 70mm Screw lid	IP67	15	-
BB1-0921-0026	120mm x 170mm x 70mm Transparent Cover	IP67	15	-
BB1-0931-0066	120mm x 170mm x 140mm Screw lid	IP67	1	40
BB1-0921-0066	120mm x 170mm x 140mm Transparent Cover	IP67	1	40
BB1-0631-0066	120mm x 224mm x 140mm Screw lid	IP67	1	30
BB1-0621-0066	120mm x 224mm x 140mm Transparent Cover	IP67	1	30
BB1-0631-0006	120mm x 255mm x 80mm Screw lid	IP67	10	0
BB1-0731-0006	210mm x 300mm x 90mm Screw lid	IP67	4	0
BB1-0731-0066	220mm x 300mm x 140mm Screw lid	IP67	1	10
BB1-0721-0066	220mm x 300mm x 140mm Transparent Cover	IP67	1	10
BB1-1231-0096	300mm x 535mm x 150mm Screw lid	IP67	2	0
BB1-1221-0096	300mm x 535mm x 150mm Transparent Cover	IP67	2	0
BB1-1031-0076	340mm x 340mm x 160mm Screw lid	IP67	1	6
BB1-1021-0076	340mm x 340mm x 160mm Transparent Cover	IP67	1	6

Ø80x45mm.
Screw lid



Halogen Free
BB1-1431-0006 / IP67

340x340x160

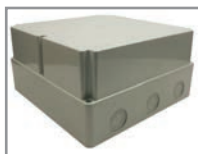

Halogen Free
BB1-1031-0073 / IP44
BB1-1031-0076 / IP67

340x340x160



Halogen Free
BB1-1021-0073 / IP44
BB1-1021-0076 / IP67

300x535x150



Halogen Free
BB1-1231-0092 / IP44
BB1-1231-0096 / IP67

300x535x150

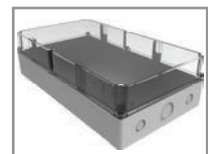

Halogen Free
BB1-1221-0092 / IP44
BB1-1221-0096 / IP67

Product Code	Description	IP	Box	Pack
BB2-1431-0006	Ø80x45mm. Screw lid	IP67	16	192
BB2-0431-0086	95mm x 95mm x 60mm Screw lid	IP67	8	96
BB2-1231-0026	110mm x 110mm x 70mm Screw lid	IP67	6	72
BB2-1131-0056	110mm x 110mm x 100mm Screw lid	IP67	4	72
BB2-1121-0056	110mm x 110mm x 100mm Transparent Cover	IP67	4	72
BB2-1331-0026	110mm x 150mm x 70mm Screw lid	IP67	4	48
BB2-0531-0006	120mm x 120mm x 70mm Screw lid	IP67	6	72
BB2-0531-0066	120mm x 120mm x 140mm Screw lid	IP67	1	60
BB2-0521-0066	120mm x 120mm x 140mm Transparent Cover	IP67	1	60
BB2-0931-0026	120mm x 170mm x 70mm Screw lid	IP67	15	-
BB2-0921-0026	120mm x 170mm x 70mm Transparent Cover	IP67	15	-
BB2-0931-0066	120mm x 170mm x 140mm Screw lid	IP67	1	40
BB2-0921-0066	120mm x 170mm x 140mm Transparent Cover	IP67	1	40
BB2-0631-0066	120mm x 224mm x 140mm Screw lid	IP67	1	30
BB2-0621-0066	120mm x 224mm x 140mm Transparent Cover	IP67	1	30
BB2-0631-0006	120mm x 255mm x 80mm Screw lid	IP67	10	0
BB2-0731-0006	210mm x 300mm x 90mm Screw lid	IP67	4	0
BB2-0731-0066	220mm x 300mm x 140mm Screw lid	IP67	1	10
BB2-0721-0066	220mm x 300mm x 140mm Transparent Cover	IP67	1	10
BB2-1231-0096	300mm x 535mm x 150mm Screw lid	IP67	2	0
BB2-1221-0096	300mm x 535mm x 150mm Transparent Cover	IP67	2	0
BB2-1031-0076	340mm x 340mm x 160mm Screw lid	IP67	1	6
BB2-1021-0076	340mm x 340mm x 160mm Transparent Cover	IP67	1	6

Ø80x45mm.
Screw lid



BB2-1431-0006 / IP67

340x340x160

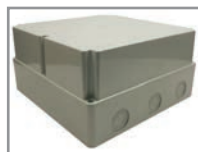

BB2-1031-0073 / IP44
BB2-1031-0076 / IP67

340x340x160

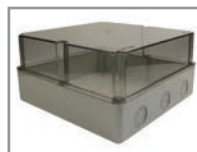

BB2-1021-0073 / IP44
BB2-1021-0076 / IP67

300x535x150



BB2-1231-0092 / IP44
BB2-1231-0096 / IP67

300x535x150



BB2-1221-0092 / IP44
BB2-1221-0096 / IP67

Product Code	Description	IP	Box	Pack
BB3-2103-1017	65mm x 65mm x 40mm Aluminum	IP67	1	16
BB3-2113-1017	65mm x 100mm x 40mm Aluminum	IP67	1	10
BB3-2131-0087	80mm x 80mm x 60mm Aluminum	IP67	1	65
BB3-2131-0097	80mm x 80mm x 73mm Aluminum	IP67	1	45
BB3-2231-0097	80mm x 130mm x 73mm Aluminum	IP67	1	35
BB3-2331-0097	80mm x 170mm x 73mm Aluminum	IP67	1	22
BB3-2431-0097	80mm x 230mm x 73mm Aluminum	IP67	1	15
BB3-2531-0107	100mm x 100mm x 75mm Aluminum	IP67	1	30
BB3-2123-1107	100mm x 130mm x 75mm Aluminum	IP67	1	24
BB3-2631-0047	130mm x 130mm x 90mm Aluminum	IP67	1	18
BB3-2731-0047	130mm x 190mm x 90mm Aluminum	IP67	1	12
BB3-2133-1047	130mm x 230mm x 90mm Aluminum	IP67	1	9
BB3-2143-1047	160mm x 160mm x 90mm Aluminum	IP67	1	30
BB3-2153-1047	160mm x 260mm x 90mm Aluminum	IP67	1	1
BB3-2831-0047	170mm x 190mm x 90mm Aluminum	IP67	1	1
BB3-2931-0047	190mm x 250mm x 90mm Aluminum	IP67	1	1
BB3-2163-1047	190mm x 350mm x 90mm Aluminum	IP67	1	1
BB3-2160-1047	190mm x 350mm x 90mm Aluminum (Hinged)	IP67	1	1
BB3-2173-1057	250mm x 250mm x 110mm Aluminum	IP67	1	1
BB3-2170-1057	250mm x 250mm x 110mm Aluminum (Hinged)	IP67	1	1
BB3-2183-1067	310mm x 400mm x 140mm Aluminum	IP67	1	1
BB3-2180-1067	310mm x 400mm x 140mm Aluminum (Hinged)	IP67	1	1
BB3-2193-1067	230mm x 330mm x 140mm Aluminum	IP67	1	1
BB3-2190-1067	230mm x 330mm x 140mm Aluminum (Hinged)	IP67	1	1

65x65x40



BB3-2103-1017

65x100x40



BB3-2113-1017

80x80x60



BB3-2131-0087

80x80x73



BB3-2131-0097

80x130x73



BB3-2231-0097

80x170x73



BB3-2331-0097

80x230x73



BB3-2431-0097

100x100x75



BB3-2531-0107

100x130x75



BB3-2123-1107

130x130x90



BB3-2631-0047

130x190x90

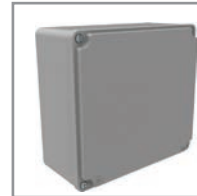

BB3-2731-0047

130x230x90



BB3-2133-1047

160x160x90

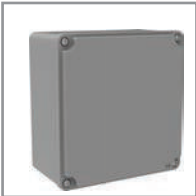

BB3-2143-1047

160x260x90



BB3-2153-1047

170x190x90

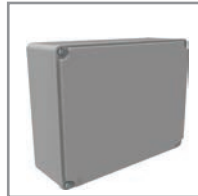

BB3-2831-0047

190x250x90



BB3-2931-0047

190x350x90



BB3-2163-1047

190x350x90 Menteşeli



BB3-2160-1047

250x250x110



BB3-2173-1057

250x250x110 Menteşeli



BB3-2170-1057

310x400x140

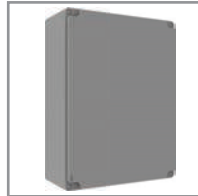

BB3-2183-1067

310x400x140 Menteşeli

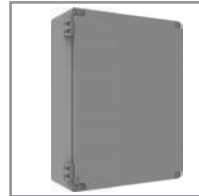

BB3-2180-1067

230x330x140

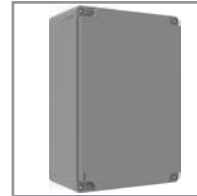

BB3-2193-1067

230x330x140 Menteşeli



BB3-2190-1067

Product Code	Description	IP	Box	Pack
BT3-1011-0002	Emergency Push Button Box (Yellow)	IP44	16	192
BT3-1000-0002	Button Box For Single Button (Black)	IP44	16	192
BT3-2000-0002	Button Box For Double Button (Black)	IP44	12	144
BT3-3000-0002	Button Box For Triple Button (Black)	IP44	8	96
BT3-4000-0002	Button Box For Quad Button (Black)	IP44	6	72
BT3-5000-0002	Button Box For Five Button (Black)	IP44	6	72

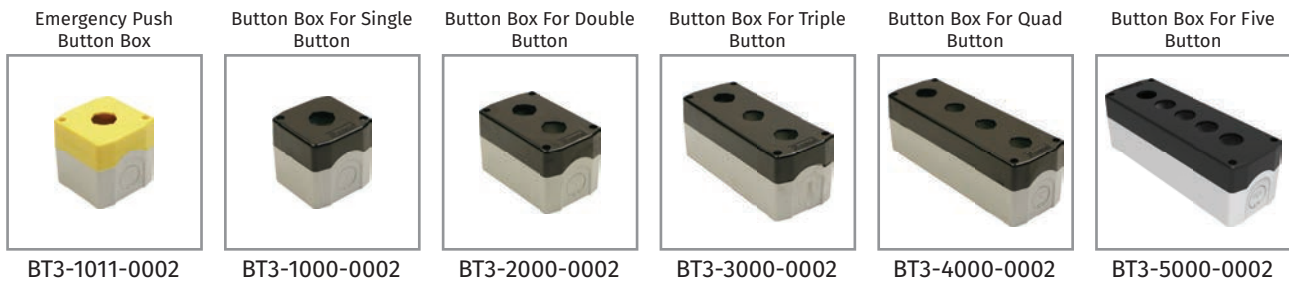

Product Code	Description	IP	Box	Pack
BT3-1011-0006	Emergency Push Button Box (Yellow)	IP67	16	192
BT3-1000-0006	Button Box For Single Button (Black)	IP67	16	192
BT3-2000-0006	Button Box For Double Button (Black)	IP67	12	144
BT3-3000-0006	Button Box For Triple Button (Black)	IP67	8	96
BT3-4000-0006	Button Box For Quad Button (Black)	IP67	6	72
BT3-5000-0006	Button Box For Five Button (Black)	IP67	6	72

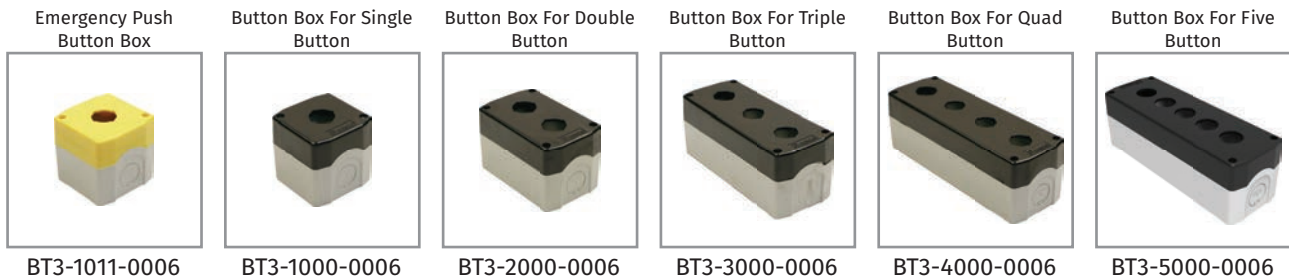

Product Code	Description	IP	Box	Pack
BT3-1020-0002	10A. Pacco Switch Box	IP44	16	192
BT3-2030-0002	25A. Pacco Switch Box	IP44	12	144
BT3-4040-0002	Fuse and Socket Box	IP44	6	72
BT3-4050-0002	1/16A. 220V. Fuse and with Socket Box	IP44	6	72
BT3-4060-0002	1/16A. 220V. Signal Fuse and with Socket Box	IP44	6	72



Product Code	Description	IP	Box	Pack
BT4-1001-0007	Button Box For Single Button 80x80x60	IP67	1	65
BT4-1001-0017	Button Box For Single Button 80x80x73	IP67	1	45
BT4-2001-0007	Button Box For Double Button 80x130x73	IP67	1	35
BT4-3001-0007	Button Box For Triple Button 80x170x73	IP67	1	22
BT4-3001-0017	Button Box For Quad Button 80x170x73	IP67	1	22
BT4-4001-0007	Button Box For Quintet Button 80x230x73	IP67	1	15
BT4-4001-0017	Button Box For Six Button 80x230x73	IP67	1	15

Button Box For Single Button
80x80x60



BT4-1001-0007

Button Box For Single Button
80x80x73



BT4-1001-0017

Button Box For Double Button
80x130x73



BT4-2001-0007

Button Box For Triple Button
80x170x73



BT4-3001-0007

Button Box For Quad Button
80x170x73



BT4-3001-0017

Button Box For Quintet Button
80x230x73



BT4-4001-0007

Button Box For Six Button
80x230x73



BT4-4001-0017

Product Code	Description	IP	Box	Pack
BT4-1071-0007	Button Box For Single Button Protected 80x80x60	IP67	1	65
BT4-1071-0017	Button Box For Single Button Protected 80x80x73	IP67	1	45
BT4-2071-0007	Button Box For Double Button Protected 80x130x73	IP67	1	35
BT4-3071-0007	Button Box For Triple Button Protected 80x170x73	IP67	1	22
BT4-3071-0017	Button Box For Quad Button Protected 80x170x73	IP67	1	22
BT4-4071-0007	Button Box For Quintet Button Protected 80x230x73	IP67	1	15
BT4-4071-0017	Button Box For Six Button Protected 80x230x73	IP67	1	15

Button Box For Single
Button Protected
80x80x60



BT4-1071-0007

Button Box For Single
Button Protected
80x80x73



BT4-1071-0017

Button Box For Double
Button Protected
80x130x73



BT4-2071-0007

Button Box For Triple
Button Protected
80x170x73



BT4-3071-0007

Button Box For Quad
Button Protected
80x170x73



BT4-3071-0017

Button Box For Quintet
Button Protected
80x230x73



BT4-4071-0007

Button Box For Six Button
Protected
80x230x73



BT4-4071-0017

Plastic

4 Pcs. 1/16A. 220V. Socket
3x1,5mm TTR 15 Mt. Capacity
Plastic Cable Reel



BM7-1103-0000

4 Pcs. 1/16A. 220V. Socket
3x1,5mm TTR 15 Mt. Cable
Plastic Cable Reel



BM7K1103-0000

Plastic

4 Pcs. 1/16A. 220V. Socket
3x1,5mm TTR 25 Mt. Capacity
Plastic Cable Reel



BM8-2103-0000

4 Pcs. 1/16A. 220V. Socket
3x1,5mm TTR 25 Mt. Cable
Plastic Cable Reel



BM8K2103-0000

4 Pcs. 1/16A. 220V. Socket
3x1,5mm TTR 25 Mt. Capacity
Thermal Fuse Plastic Cable Reel



BM8-2104-0000

4 Pcs. 1/16A. 220V. Socket
3x1,5mm TTR 25 Mt. Cable
Thermal Fuse Plastic Cable Reel



BM8K2104-0000

Plastic

4 Pcs. 1/16A. 220V. Socket
3x1,5mm TTR 50 Mt. Capacity
Plastic Cable Reel



BM9-3103-0000

4 Pcs. 1/16A. 220V. Socket
3x1,5mm TTR 50 Mt. Cable
Plastic Cable Reel



BM9K3103-0000

4 Pcs. 1/16A. 220V. Socket
3x1,5mm TTR 50 Mt. Capacity
Thermal Fuse Plastic Cable Reel



BM9-3104-0000

4 Pcs. 1/16A. 220V. Socket
3x1,5mm TTR 50 Mt. Cable
Thermal Fuse Plastic Cable Reel



BM9K3104-0000

Plastic

3 Pcs. 1/16A. 220V. IP54 Socket
3x1,5mm TTR 25 Mt. Capacity
Thermal Fuse Plastic Cable Reel



BM8-2357-0004

3 Pcs. 1/16A. 220V. IP54 Socket
3x1,5mm TTR 50 Mt. Capacity
Thermal Fuse Plastic Cable Reel



BM9-3357-0004

Metal

Empty 3x1,5mm TTR 25 Mt. Capacity
with Protection Cover
Metal Cable Reel



BM1-2102-0000

4 Pcs. 1/16A. 220V. Socket
3x1,5mm TTR 25 Mt. Capacity
Metal Cable Reel



BM1-2103-0000

4 Pcs. 1/16A. 220V. Socket
3x1,5mm TTR 25 Mt. Cable
Metal Cable Reel



BM1K2103-0000

Metal

3x1,5mm TTR 50 Mt. Capacity with Protection Cover Metal Cable Reel



BM2-3102-0000

4 Pcs. 1/16A. 220V. Socket 3x1,5mm TTR 50 Mt. Capacity Metal Cable Reel



BM2-3103-0000

4 Pcs. 1/16A. 220V. Socket 3x1,5mm TTR 50 Mt. Cable Metal Cable Reel



BM2K3103-0000

4 Pcs. 1/16A. 220V. Socket 3x2,5mm TTR 25 Mt. Cable Metal Cable Reel



BM2K3103-0022

Metal

3x2,5mm TTR 50 Mt. Capacity with Protection Cover Metal Cable Reel

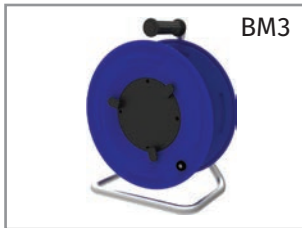

BM3-4102-0000

4 Pcs. 1/16A. 220V. Socket 3x2,5mm TTR 50 Mt. Capacity Metal Cable Reel



BM3-4403-0000

3 Pcs. 1/16A. 220V. Socket 3x2,5mm TTR 50 Mt. Capacity Metal Cable Reel

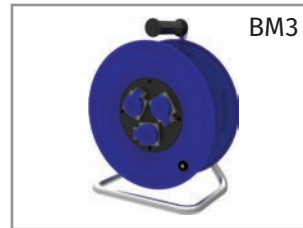

BM3-4303-0000

Metal

5x2,5mm TTR 40 Mt. Capacity Metal Cable Reel



BM4-5000-0000

5x2,5mm TTR 40 Mt. Capacity with Protection Cover Metal Cable Reel



BM4-5102-0000

6 Pcs. 1/16A. 220V. Socket 5x2,5mm TTR 40 Mt. Capacity Metal Cable Reel



BM4-5603-0000

2 Pcs. 1/16A. 220V. 1 Pc. 3/25A. 380V. Socket 5x2,5mm TTR 40 Mt. Capacity Metal Cable Reel



BM4-5203-1060

Metal

Prizsiz 5x2,5mm TTR 50 Mt. Capacity Metal Cable Reel



BM5-6000-0000

4 Pcs. 1/16A. 220V. IP67 Socket 5x2,5mm TTR 50 Mt. Capacity Metal Cable Reel



BM5-6431-0000

2 Pcs. 1/16A. 220V. 1 Pc. 5/32A. 380V. 1 Pc. 5/16A. 380V. IP67 Socket 5x2,5mm TTR 50 Mt. Capacity Metal Cable Reel



BM5-6231-1611

3 Pcs. 1/16A. 220V. Socket 5x2,5mm TTR 50 Mt. Capacity Metal Cable Reel



BM5-6303-0000

Metal

Empty 5x2,5mm TTR 100 Mt. Capacity Portable Metal Cable Reel



BM6-7000-0000

3 Pcs. 1/16A. 220V. Socket 5x2,5mm TTR 100 Mt. Capacity Portable Metal Cable Reel



BM6-7303-0000

2 Pcs. 1/16A. 220V. 2 Pcs. 5/32A. 380V. IP67 Socket 5x2,5mm TTR 100 Mt. Capacity Portable Metal Cable Reel



BM6-7231-2610

4 Pcs. 1/16A. 220V. IP67 Socket 5x2,5mm TTR 100 Mt. Capacity Portable Metal Cable Reel



BM6-7431-0000

3x1,5mm TTR 25m. Capacity

Product Code	Description	IP	Box	Pack
BM1-2102-0000	Metal Cable Reel 3x1,5mm TTR 25m. Cable Capacity with Protection Cover	IP44	1	0
BM1-2103-0000	1/16A. 4 Socket Metal Cable Reel 3x1,5mm TTR 25m. Cable Capacity	IP44	1	0
BM1K2103-0000	1/16A. 4 Socket Metal Cable Reel 3x1,5mm TTR 25m. with Cable	IP44	1	0

3x1,5mm TTR 50m. Capacity

Product Code	Description	IP	Box	Pack
BM2-3102-0000	Metal Cable Reel 3x1,5mm TTR 50m. Cable Capacity with Protection Cover	IP44	1	0
BM2-3103-0000	1/16A. 4 Socket Metal Cable Reel 3x1,5mm TTR 50m. Cable Capacity	IP44	1	0
BM2K3103-0000	1/16A. 4 Socket Metal Cable Reel 3x1,5mm TTR 50m. with Cable	IP44	1	0
BM2K3103-0022	1/16A. 220V. 4 Pcs. Socket Metal Cable Reel 3x2,5mm TTR 25m. with Cable	IP44	1	0

3x2,5mm TTR 50m. Capacity

Product Code	Description	IP	Box	Pack
BM3-4102-0000	Metal Cable Reel 3x2,5mm TTR 50m. Cable Capacity with Protection Cover	IP44	1	0
BM3-4108-2030	1/16A. 2 Pcs. 3/16A. 220V. 1 Pc. Socket Metal Cable Reel 3x2,5mm TTR 50m. Cable Capacity	IP44	1	0
BM3-4203-0000	1/16A. 2 Pcs. Socket Metal Cable Reel 3x2,5mm TTR 50m. Cable Capacity	IP44	1	0
BM3-4224-0000	3/16A. 24V. 2 Pcs. Socket Metal Cable Reel 3x2,5mm TTR 50m. Cable Capacity	IP44	1	0
BM3-4303-0000	1/16A. 220V. 3 Pcs. Socket Metal Cable Reel 3x2,5mm TTR 50m. Cable Capacity	IP44	1	0
BM3-4203-1060	1/16A. 220V. 2 Pcs. 3/25A. 380V. 1 Pc. Socket Metal Cable Reel 3x2,5mm TTR 50m. Cable Capacity	IP44	1	0
BM3-4403-0000	1/16A. 220V. 4 Pcs. Socket Metal Cable Reel 3x2,5mm TTR 50m. Cable Capacity	IP44	1	0
BM3-4357-0004	1/16A. 220V. IP54 3 Pcs. Socket Metal Cable Reel 3x2,5mm TTR 50m. Cable Capacity with Thermal Fuse	IP54	1	0
BM3-4303-0004	1/16A. 220V. 3 Pcs. Socket Metal Cable Reel 3x2,5mm TTR 50m. Cable Capacity with Thermal Fuse	IP44	1	0
BM3-4321-0004	1/16A. 220V. 3 Pcs. French Socket Metal Cable Reel 3x2,5mm TTR 50m. Cable Capacity with Thermal Fuse	IP44	1	0
BM3K4403-0000	1/16A. 220V. 4 Pcs. Socket Metal Cable Reel 3x2,5mm TTR 50m. with Cable	IP44	1	0

5x2,5mm TTR 40m. Capacity

Product Code	Description	IP	Box	Pack
BM4-5000-0000	Metal Cable Reel Without Socket 5x2,5mm TTR 40m. Cable Capacity	IP44	1	0
BM4-5102-0000	Metal Cable Reel 5x2,5mm TTR 40m. Cable Capacity with Protection Cover	IP44	1	0
BM4-5103-1160	1/16A. 220V. 1 Pc. 5/32A. 380V. 1 Pc. Socket Metal Cable Reel 5x2,5mm TTR 40m. Capacity	IP44	1	0
BM4-5103-2060	1/16A. 220V. 1 Pc. 3/25A. 380V. 2 Pcs. Socket Metal Cable Reel 5x2,5mm TTR 40m. Capacity	IP44	1	0
BM4-5112-2030	1/16A. 220V. 2 Pcs. 5/16A. 380V. 1 Pc. Socket Metal Cable Reel 5x2,5mm TTR 40m. Capacity	IP44	1	0
BM4-5203-1060	1/16A. 220V. 2 Pcs. 3/25A. 380V. 1 Pc. Socket Metal Cable Reel 5x2,5mm TTR 40m. Capacity	IP44	1	0
BM4-5203-1080	1/16A. 220V. 2 Pcs. 3/16A. 220V. 1 Pc. Socket Metal Cable Reel 5x2,5mm TTR 40m. Capacity	IP44	1	0
BM4-5203-1160	1/16A. 220V. 2 Pcs. 5/32A. 380V. 1 Pc. Socket Metal Cable Reel 5x2,5mm TTR 40m. Capacity	IP44	1	0
BM4-5203-2060	1/16A. 220V. 2 Pcs. 3/25A. 380V. 2 Pcs. Socket Metal Cable Reel 5x2,5mm TTR 40m. Capacity	IP44	1	0
BM4-5203-2080	1/16A. 220V. 2 Pcs. 3/16A. 220V. 2 Pcs. Socket Metal Cable Reel 5x2,5mm TTR 40m. Capacity	IP44	1	0
BM4-5203-2110	1/16A. 220V. 2 Pcs. 4/16A. 380V. 2 Pcs. Socket Metal Cable Reel 5x2,5mm TTR 40m. Capacity	IP44	1	0
BM4-5203-2120	1/16A. 220V. 2 Pcs. 5/16A. 380V. 2 Pcs. Socket Metal Cable Reel 5x2,5mm TTR 40m. Capacity	IP44	1	0
BM4-5203-2150	1/16A. 220V. 2 Pcs. 4/32A. 380V. 2 Pcs. Socket Metal Cable Reel 5x2,5mm TTR 40m. Capacity	IP44	1	0
BM4-5203-2160	1/16A. 220V. 2 Pcs. 5/32A. 380V. 2 Pcs. Socket Metal Cable Reel 5x2,5mm TTR 40m. Capacity	IP44	1	0
BM4-5303-0000	1/16A 220V IP44 3 Pcs. Socket Metal Cable Reel 5x2,5mm TTR 40m. Capacity	IP44	1	0
BM4-5303-1060	1/16A. 220V. 3 Pcs. 3/25A. 380V. 1 Pc. Socket Metal Cable Reel 5x2,5mm TTR 40m. Capacity	IP44	1	0
BM4-5303-1110	1/16A. 220V. 3 Pcs. 4/16A. 380V. 1 Pc. Socket Metal Cable Reel 5x2,5mm TTR 40m. Capacity	IP44	1	0
BM4-5303-1120	1/16A. 220V. 3 Pcs. 5/16A. 380V. 1 Pc. Socket Metal Cable Reel 5x2,5mm TTR 40m. Capacity	IP44	1	0
BM4-5303-1150	1/16A. 220V. 3 Pcs. 4/32A. 380V. 1 Pc. Socket Metal Cable Reel 5x2,5mm TTR 40m. Capacity	IP44	1	0
BM4-5303-1160	1/16A. 220V. 3 Pcs. 5/32A. 380V. 1 Pc. Socket Metal Cable Reel 5x2,5mm TTR 40m. Capacity	IP44	1	0
BM4-5603-0000	1/16A. 220V. 6 Pcs. Socket Metal Cable Reel 5x2,5mm TTR 40m. Capacity	IP44	1	0
BM4-5031-0000	Metal Cable Reel Without Socket 5x2,5mm TTR 40m. Cable Capacity	IP67	1	0
BM4-5231-1610	1/16A. 220V. 2 Pcs. 5/32A. 380V. 1 Pc. IP67 Socket Metal Cable Reel 5x2,5mm TTR 40m. Capacity	IP67	1	0
BM4-5431-0000	1/16A. 220V. 4 Pcs. IP67 Socket Metal Cable Reel 5x2,5mm TTR 40m. Capacity	IP67	1	0
BM4-5231-2610	1/16A. 220V. 2 Pcs. 5/32A. 380V. 2 Pcs. IP67 Socket Metal Cable Reel 5x2,5mm TTR 40m. Capacity	IP67	1	0
BM4-5231-1470	1/16A. 220V. 2 Pcs. 5/16A. 380V. 1 Pc. IP67 Socket Metal Cable Reel 5x2,5mm TTR 40m. Capacity	IP67	1	0
BM4-5231-1611	1/16A. 220V. 2 Pcs. 5/32A. 380V. 1 Pc. 5/16A. 380V. 1 Pc. IP67 Socket Metal Cable Reel 5x2,5mm TTR 40m. Capacity	IP67	1	0

5x2,5mm TTR 50m. Capacity

Product Code	Description	IP	Box	Pack
BM5-6000-0000	Metal Cable Reel Without Socket 5x2,5mm TTR 50m. Cable Capacity	IP44	1	0
BM5-6102-0000	Metal Cable Reel 5x2,5mm TTR 50m. Cable Capacity with Protection Cover	IP44	1	0
BM5-6103-1161	1/16A. 220V. 1 Pc. 5/16A. 380V. 1 Pc. 5/32A. 380V. 1 Pc. Socket Metal Cable Reel 5x2,5mm TTR 50m. Capacity	IP44	1	0
BM5-6103-2060	1/16A. 220V. 1 Pc. 3/25A. 380V. 2 Pcs. Socket Metal Cable Reel 5x2,5mm TTR 50m. Capacity	IP44	1	0
BM5-6116-0000	5/32A. 380V. 1 Pc. Socket Metal Cable Reel 5x2,5mm TTR 50m. Capacity	IP44	1	0
BM5-6203-1200	1/16A. 220V. 2 Pcs. 5/63A. 380V. 1 Pc. Socket Metal Cable Reel 5x2,5mm TTR 50m. Capacity	IP44	1	0
BM5-6203-2150	1/16A. 220V. 2 Pcs. 4/32A. 380V. 2 Pcs. Socket Metal Cable Reel 5x2,5mm TTR 50m. Capacity	IP44	1	0
BM5-6203-2160	1/16A. 220V. 2 Pcs. 5/32A. 380V. 2 Pcs. Socket Metal Cable Reel 5x2,5mm TTR 50m. Capacity	IP44	1	0
BM5-6212-2030	1/16A. 220V. 2 Pcs. 5/16A. 380V. 2 Pcs. Socket Metal Cable Reel 5x2,5mm TTR 50m. Capacity	IP44	1	0
BM5-6303-0000	1/16A. 220V. 3 Pcs. Socket Metal Cable Reel 5x2,5mm TTR 50m. Capacity	IP44	1	0
BM5-6303-1160	1/16A. 220V. 3 Pcs. 5/32A. 380V. 1 Pc. Socket Metal Cable Reel 5x2,5mm TTR 50m. Capacity	IP44	1	0
BM5-6304-0000	1/16A. 220V. M.P. 3 Pcs. Socket Metal Cable Reel 5x2,5mm TTR 50m. Capacity	IP44	1	0
BM5-6315-0000	4/32A. 380V. 3 Pcs. Socket Metal Cable Reel 5x2,5mm TTR 50m. Capacity	IP44	1	0
BM5-6316-0000	5/32A. 380V. 3 Pcs. Socket Metal Cable Reel 5x2,5mm TTR 50m. Capacity	IP44	1	0
BM5-6403-0000	1/16A. 220V. 4 Pcs. Socket Metal Cable Reel 5x2,5mm TTR 50m. Capacity	IP44	1	0
BM5-6031-0000	Prizsiz Metal Cable Reel 5x2,5mm TTR 50m. Capacity	IP67	1	0
BM5-6231-2610	1/16A. 220V. 2 Pcs. 5/32A. 380V. 2 Pcs. IP67 Socket Metal Cable Reel 5x2,5mm TTR 50m. Capacity	IP67	1	0
BM5-6231-1611	1/16A. 220V. 2 Pcs. 5/32A. 380V. 1 Pc. 5/16A. 380V. 1 Pc. IP67 Socket Metal Cable Reel 5x2,5mm TTR 50m. Capacity	IP67	1	0
BM5-6431-0000	1/16A. 220V. 4 Pcs. IP67 Socket Metal Cable Reel 5x2,5mm TTR 50m. Capacity	IP67	1	0

5x2,5mm TTR 100m. Capacity

Product Code	Description	IP	Box	Pack
BM6-7000-0000	Metal Cable Reel Without Socket 5x2,5mm TTR 100m. Capacity Portable	IP44	1	0
BM6-7102-0000	Metal Cable Reel 5x2,5mm TTR 100m. Cable Capacity with Protection Cover	IP44	1	0
BM6-7103-1061	1/16A. 220V. 1 Pc. 3/25A. 380V. 1 Pc. 5/32A. 380V. 1 Pc. Socket Metal Cable Reel 5x2,5mm TTR 100m. Capacity Portable	IP44	1	0
BM6-7103-2060	1/16A. 220V. 1 Pc. 3/25A. 380V. 2 Pcs. Socket Metal Cable Reel 5x2,5mm TTR 100m. Capacity Portable	IP44	1	0
BM6-7203-1060	1/16A. 220V. 2 Pcs. 3/25A. 380V. 1 Pc. Socket Metal Cable Reel 5x2,5mm TTR 100m. Capacity Portable	IP44	1	0
BM6-7203-1061	1/16A. 220V. 2 Pcs. 3/25A. 380V. 1 Pc. 5/16A. 380V. 1 Pc. Socket Metal Cable Reel 5x2,5mm TTR 100m. Capacity Portable	IP44	1	0
BM6-7203-1062	1/16A. 220V. 2 Pcs. 3/25A. 380V. 1 Pc. 5/32A. 380V. 1 Pc. Socket Metal Cable Reel 5x2,5mm TTR 100m. Capacity Portable	IP44	1	0
BM6-7203-1120	1/16A. 220V. 2 Pcs. 5/16A. 380V. 1 Pc. Socket Metal Cable Reel 5x2,5mm TTR 100m. Capacity Portable	IP44	1	0
BM6-7203-1121	1/16A. 220V. 2 Pcs. 5/16A. 380V. 1 Pc. 5/32A. 380V. 1 Pc. Socket Metal Cable Reel 5x2,5mm TTR 100m. Capacity Portable	IP44	1	0
BM6-7203-1200	1/16A. 220V. 2 Pcs. 5/63A. 380V. 1 Pc. Socket Metal Cable Reel 5x2,5mm TTR 100m. Capacity Portable	IP44	1	0
BM6-7206-2030	1/16A. 220V. 2 Pcs. 3/25A. 380V. 2 Pcs. Socket Metal Cable Reel 5x2,5mm TTR 100m. Capacity Portable	IP44	1	0
BM6-7211-2030	1/16A. 220V. 2 Pcs. 4/16A. 380V. 2 Pcs. Socket Metal Cable Reel 5x2,5mm TTR 100m. Capacity Portable	IP44	1	0
BM6-7212-2030	1/16A. 220V. 2 Pcs. 5/16A. 380V. 2 Pcs. Socket Metal Cable Reel 5x2,5mm TTR 100m. Capacity Portable	IP44	1	0
BM6-7216-2030	1/16A. 220V. 2 Pcs. 5/32A. 380V. 2 Pcs. Socket Metal Cable Reel 5x2,5mm TTR 100m. Capacity Portable	IP44	1	0
BM6-7303-0000	1/16A. 220V. 3 Pcs. Socket Metal Cable Reel 5x2,5mm TTR 100m. Capacity Portable	IP44	1	0
BM6-7303-1160	1/16A. 220V. 3 Pcs. 5/32A. 380V. 1 Pc. Socket Metal Cable Reel 5x2,5mm TTR 100m. Capacity Portable	IP44	1	0
BM6-7403-0000	1/16A. 220V. 4 Pcs. Socket Metal Cable Reel 5x2,5mm TTR 100m. Capacity Portable	IP44	1	0
BM6-7406-0000	3/25A. 380V. 4 Pcs. Socket Metal Cable Reel 5x2,5mm TTR 100m. Capacity Portable	IP44	1	0
BM6-7031-0000	Prizsiz Metal Cable Reel 5x2,5mm TTR 100m. Capacity	IP67	1	0
BM6-7331-1610	1/16A. 220V. 3 Pcs. 5/32A. 380V. 1 Pc. IP67 Socket Metal Cable Reel 5x2,5mm TTR 100m. Capacity Portable	IP67	1	0
BM6-7231-2610	1/16A. 220V. 2 Pcs. 5/32A. 380V. 2 Pcs. IP67 Socket Metal Cable Reel 5x2,5mm TTR 100m. Capacity Portable	IP67	1	0
BM6-7231-1611	1/16A. 220V. 2 Pcs. 5/32A. 380V. 1 Pc. 5/16A. 380V. 1 Pc. IP67 Socket Metal Cable Reel 5x2,5mm TTR 100m. Capacity Portable	IP67	1	0
BM6-7431-0000	1/16A. 220V. 4 Pcs. IP67 Socket Metal Cable Reel 5x2,5mm TTR 100m. Capacity Portable	IP67	1	0

3x1,5mm TTR 15m. Capacity

Product Code	Description	IP	Box	Pack
BM7-1103-0000	1/16A. 4 Pcs. Socket Plastic Cable Reel 3x1,5mm TTR 15m. Cable Capacity	IP44	1	0
BM7K1103-0000	1/16A. 4 Pcs. Socket Plastic Cable Reel 3x1,5mm TTR 15m. with Cable	IP44	1	0

3x1,5mm TTR 25m. Capacity

Product Code	Description	IP	Box	Pack
BM8-2102-0000	Plastic Cable Reel Without Socket 3x1,5mm TTR 25m. Cable Capacity	IP44	1	0
BM8-2103-0000	1/16A. 4 Pcs. Socket Plastic Cable Reel 3x1,5mm TTR 25m. Cable Capacity	IP44	1	0
BM8-2305-0000	1/16A. 3 Pcs. Socket Plastic Cable Reel 3x1,5mm TTR 25m. Cable Capacity	IP44	1	0
BM8-2306-0000	1/16A. 3 Pcs. French Socket Plastic Cable Reel 3x1,5mm TTR 25m. Cable Capacity	IP44	1	0
BM8-2357-0004	1/16A. 3 Pcs. Socket Plastic Cable Reel 3x1,5mm TTR 25m. Cable Capacity with Thermal Fuse	IP54	1	0
BM8-2104-0000	1/16A. 4 Pcs. Socket Plastic Cable Reel 3x1,5mm TTR 25m. Cable Capacity with Thermal Fuse	IP44	1	0
BM8K2103-0000	1/16A. 4 Pcs. Socket Plastic Cable Reel 3x1,5mm TTR 25m. with Cable	IP44	1	0
BM8K2104-0000	1/16A. 4 Pcs. Socket Plastic Cable Reel 3x1,5mm TTR 25m. Cable with Thermal Fuse	IP44	1	0

3x1,5mm TTR 50m. Capacity

Product Code	Description	IP	Box	Pack
BM9-3102-0000	Plastic Cable Reel 3x1,5mm TTR 50m. Cable Capacity with Protection Cover	IP44	1	0
BM9-3103-0000	1/16A. 4 Pcs. Socket Plastic Cable Reel 3x1,5mm TTR 50m. Cable Capacity	IP44	1	0
BM9-3104-0000	1/16A. 4 Pcs. Socket Plastic Cable Reel 3x1,5mm TTR 50m. Cable Capacity with Thermal Fuse	IP44	1	0
BM9-3357-0004	1/16A. 3 Pcs. Socket Plastic Cable Reel 3x1,5mm TTR 50m. Cable Capacity with Thermal Fuse	IP54	1	0
BM9-3305-0000	1/16A. 3 Pcs. Socket Plastic Cable Reel 3x1,5mm TTR 50m. Cable Capacity	IP44	1	0
BM9-3306-0000	1/16A. 3 Pcs. French Socket Plastic Cable Reel 3x1,5mm TTR 50m. Cable Capacity	IP44	1	0
BM9K3103-0000	1/16A. 4 Pcs. Socket Plastic Cable Reel 3x1,5mm TTR 50m. with Cable	IP44	1	0
BM9K3104-0000	1/16A. 4 Pcs. Socket Plastic Cable Reel 3x1,5mm TTR 50m. Cable with Thermal Fuse	IP44	1	0



BM7-1103-0000



BM8-2305-0000



BM9-3305-0000

FOREIGN TRADE

BEMIS Electricity which is going with succes steps to be a brand at the world market, has been export to more than 60 countries. Our goal is the export to raise 65 countries for 2023.

BEMIS products meet with users of global market by BEMIS showrooms, distributors, agencies. BEMIS works way to raise of brand awareness at the world by join international fairs and promoting events.



- Russia • Egypt • Algeria • Iran • Azerbaijan • Portugal • Ukrain • Nigeria
- Bulgaria • Romania • Serbia • France • Germany • Polonia • Kyrgyzstan
- Belarus • Kazakhstan • Iraq • Turkmenistan • Uzbekistan • Tajikistan • Sweden
- Mongolia • South Africa • Kosovo • Tunisia • Jordan • Morocco • Chile • Kuwait
- Lebanon • Lithuania • Latvia • Estonia • Norway • England • Switzerland
- Georgia • Macedonia • Qatar • Saudi Arabia • Spain • India • Bosnia and Herzegovina
- Angola • Albania • China • Singapore



DISCOVER
BEMIS
WORLD